

Module 2

Data Communication Fundamentals

Lesson 7

Multiplexing of Signals

Specific Instructional Objective

On completion, the student will be able to:

- Explain the need for multiplexing
- Distinguish between multiplexing techniques
- Explain the key features of FDM and TDM
- Distinguish between synchronous and asynchronous TDM

2.7.1 Introduction

It has been observed that most of the individual data-communicating devices typically require modest data rate. But, communication media usually have much higher bandwidth. As a consequence, two communicating stations do not utilize the full capacity of a data link. Moreover, when many nodes compete to access the network, some efficient techniques for utilizing the data link are very essential. When the bandwidth of a medium is greater than individual signals to be transmitted through the channel, a medium can be shared by more than one channel of signals. The process of making the most effective use of the available channel capacity is called **Multiplexing**. For efficiency, the channel capacity can be shared among a number of communicating stations just like a large water pipe can carry water to several separate houses at once. Most common use of multiplexing is in long-haul communication using coaxial cable, microwave and optical fibre.

Figure 2.7.1 depicts the functioning of multiplexing functions in general. The **multiplexer** is connected to the **demultiplexer** by a single data link. The multiplexer combines (multiplexes) data from these 'n' input lines and transmits them through the high capacity data link, which is being demultiplexed at the other end and is delivered to the appropriate output lines. Thus, **Multiplexing** can also be defined as a technique that allows simultaneous transmission of multiple signals across a single data link.

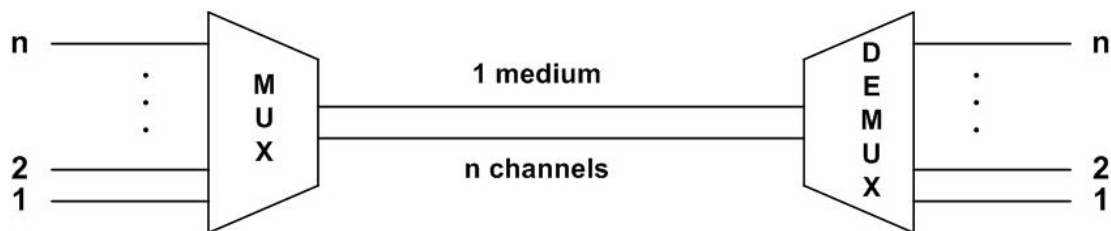

Figure 2.7.1 Basic concept of multiplexing

Multiplexing techniques can be categorized into the following three types:

- **Frequency-division multiplexing (FDM):** It is most popular and is used extensively in radio and TV transmission. Here the frequency spectrum is divided into several logical channels, giving each user exclusive possession of a particular frequency band.

- **Time-division Multiplexing (TDM):** It is also called synchronous TDM, which is commonly used for multiplexing digitized voice stream. The users take turns using the entire channel for short burst of time.
- **Statistical TDM:** This is also called asynchronous TDM, which simply improves on the efficiency of synchronous TDM.

In the following sections these techniques have been considered in detail.

2.7.2 Frequency-Division Multiplexing (FDM)

In frequency division multiplexing, the available bandwidth of a single physical medium is subdivided into several independent frequency channels. Independent message signals are translated into different frequency bands using modulation techniques, which are combined by a linear summing circuit in the multiplexer, to a composite signal. The resulting signal is then transmitted along the single channel by electromagnetic means as shown in Fig. 2.7.2. Basic approach is to divide the available bandwidth of a single physical medium into a number of smaller, independent frequency channels. Using modulation, independent message signals are translated into different frequency bands. All the modulated signals are combined in a linear summing circuit to form a composite signal for transmission. The carriers used to modulate the individual message signals are called *sub-carriers*, shown as f_1, f_2, \dots, f_n in Fig. 2.7.3 (a).



Figure 2.7.2 Basic concept of FDM

At the receiving end the signal is applied to a bank of band-pass filters, which separates individual frequency channels. The band pass filter outputs are then demodulated and distributed to different output channels as shown in Fig. 2.7.3(b).

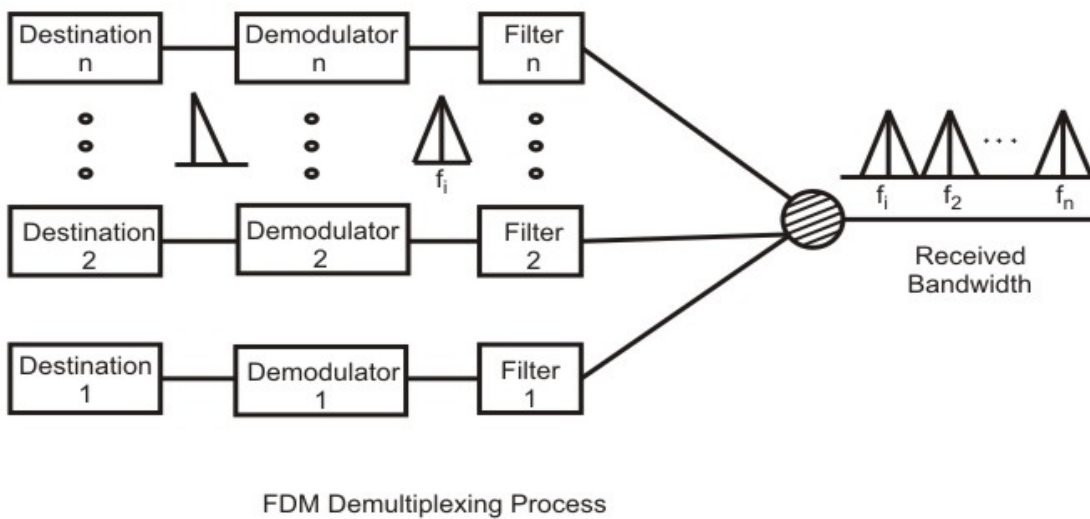
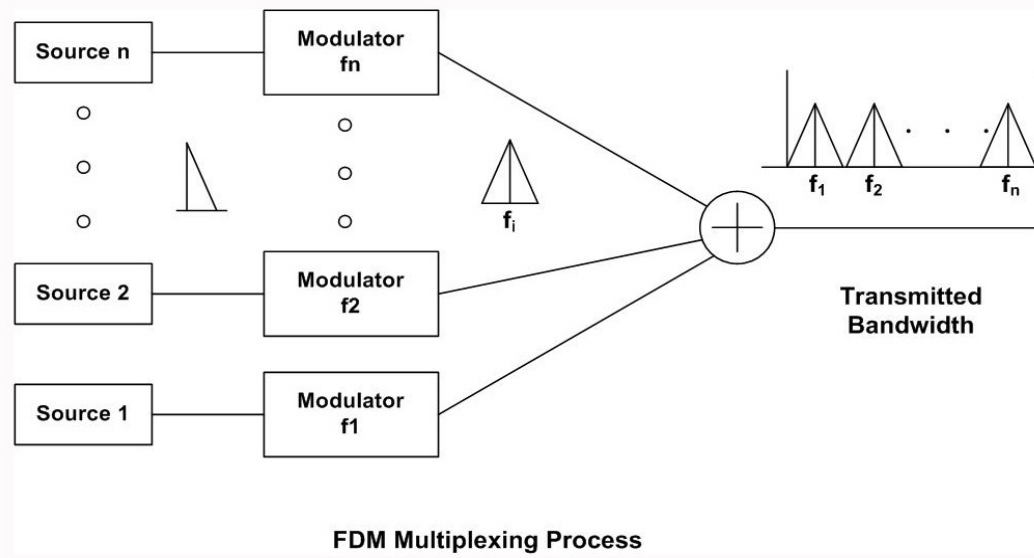

Figure 2.7.3 (a) FDM multiplexing process, (b) FDM demultiplexing process

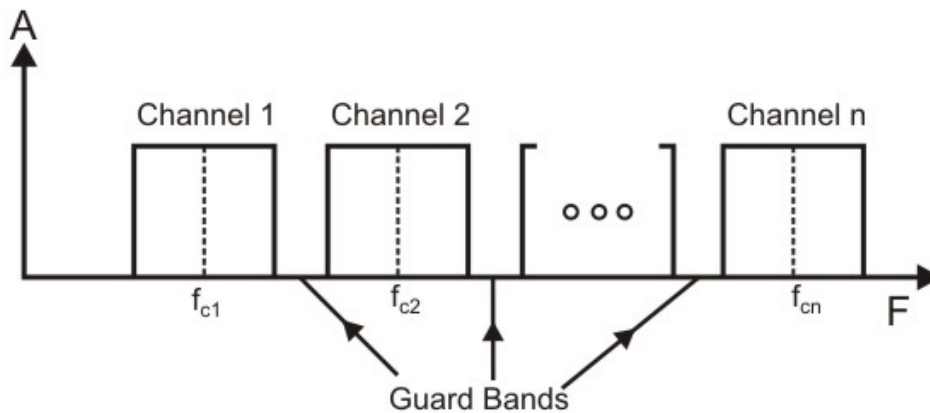

Figure 2.7.4 Use of guard bands in FDM

If the channels are very close to one other, it leads to inter-channel cross talk. Channels must be separated by strips of unused bandwidth to prevent inter-channel cross talk. These unused channels between each successive channel are known as **guard bands** as shown in Fig. 2.7.4.

FDM are commonly used in radio broadcasts and TV networks. Since, the frequency band used for voice transmission in a telephone network is 4000 Hz, for a particular cable of 48 KHz bandwidth, in the 70 to 108 KHz range, twelve separate 4 KHz sub channels could be used for transmitting twelve different messages simultaneously. Each radio and TV station, in a certain broadcast area, is allotted a specific broadcast frequency, so that independent channels can be sent simultaneously in different broadcast area. For example, the AM radio uses 540 to 1600 KHz frequency bands while the FM radio uses 88 to 108 MHz frequency bands.

2.7.3 Wavelength-Division Multiplexing

Wavelength-division multiplexing (WDM) is conceptually same as the FDM, except that the multiplexing and demultiplexing involves light signals transmitted through fibre-optic channels. The idea is the same: we are combining different frequency signals. However, the difference is that the frequencies are very high. It is designed to utilize the high data rate capability of fibre-optic cable. Very narrow band of light signal from different source are combined to make a wider band of light. At the receiver the signals are separated with the help of a demultiplexer as shown in Fig. 2.7.5.

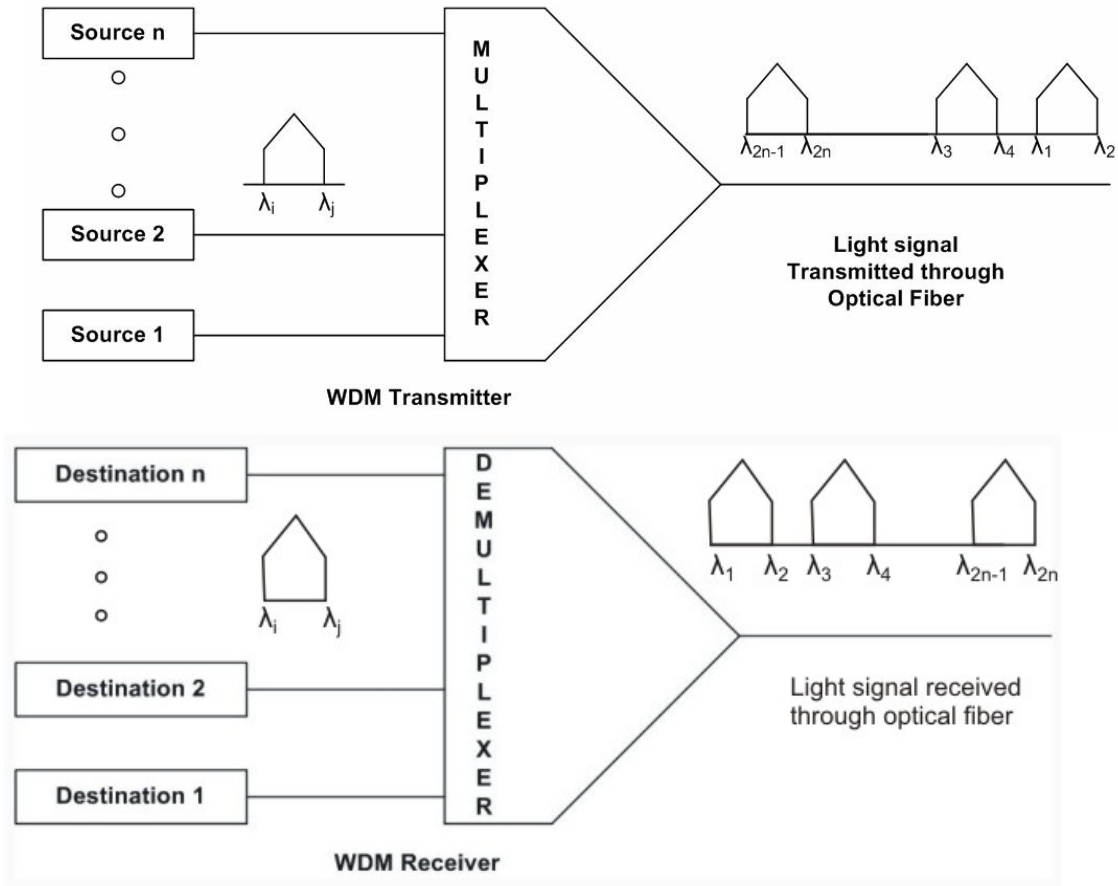

Figure 2.7.5 Basic WDM multiplexing and demultiplexing

Multiplexing and demultiplexing of light signals can be done with the help of a **prism** as shown in Fig. 2.7.6. From the basic knowledge of physics we know that light signal is bent by different amount based on the angle of incidence and wavelength of light as shown by different colours in the figure. One prism performs the role of a multiplexer by combining lights having different frequencies from different sources. The composite signal can be transmitted through an optical fibre cable over long distances, if required. At the other end of the optical fibre cable the composite signal is applied to another prism to do the reverse operation, the function of a demultiplexer.

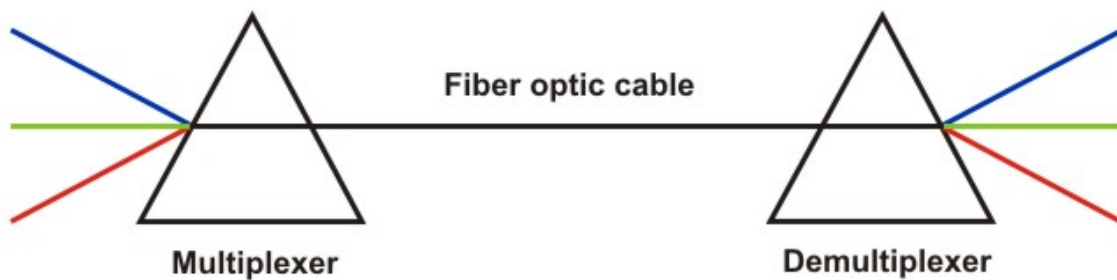

Figure 2.7.6 Multiplexing and demultiplexing of light signals with help of prisms

2.7.4 Time-Division Multiplexing (TDM)

In frequency division multiplexing, all signals operate at the same time with different frequencies, but in Time-division multiplexing all signals operate with same frequency at different times. This is a base band transmission system, where an electronic commutator sequentially samples all data source and combines them to form a composite base band signal, which travels through the media and is being demultiplexed into appropriate independent message signals by the corresponding commutator at the receiving end. The incoming data from each source are briefly buffered. Each buffer is typically one bit or one character in length. The buffers are scanned sequentially to form a composite data stream. The scan operation is sufficiently rapid so that each buffer is emptied before more data can arrive. Composite data rate must be at least equal to the sum of the individual data rates. The composite signal can be transmitted directly or through a modem. The multiplexing operation is shown in Fig. 2.7.7

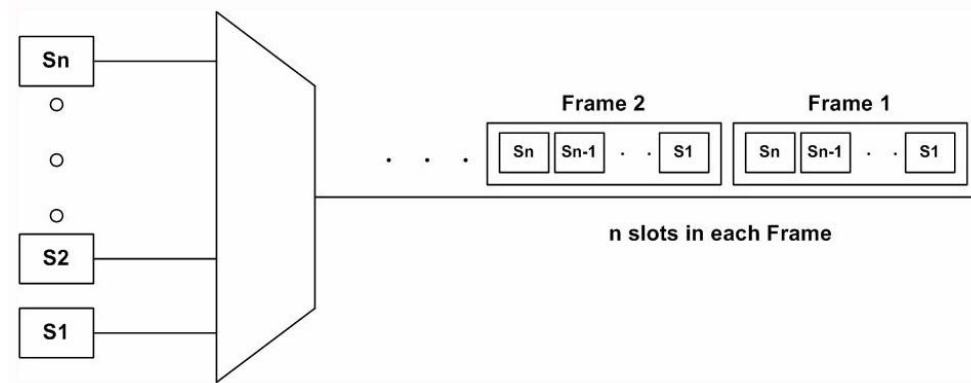

Figure 2.7.7 Time division multiplexing operation

As shown in the Fig 2.7.7 the composite signal has some *dead space* between the successive sampled pulses, which is essential to prevent interchannel cross talks. Along with the sampled pulses, one synchronizing pulse is sent in each cycle. These data pulses along with the control information form a *frame*. Each of these frames contain a cycle of time slots and in each frame, one or more slots are dedicated to each data source. The maximum bandwidth (data rate) of a TDM system should be at least equal to the same data rate of the sources.

Synchronous TDM is called synchronous mainly because each time slot is preassigned to a fixed source. The time slots are transmitted irrespective of whether the sources have any data to send or not. Hence, for the sake of simplicity of implementation, channel capacity is wasted. Although fixed assignment is used TDM, devices can handle sources of different data rates. This is done by assigning fewer slots per cycle to the slower input devices than the faster devices. Both multiplexing and demultiplexing operation for synchronous TDM are shown in Fig. 2.7.8.

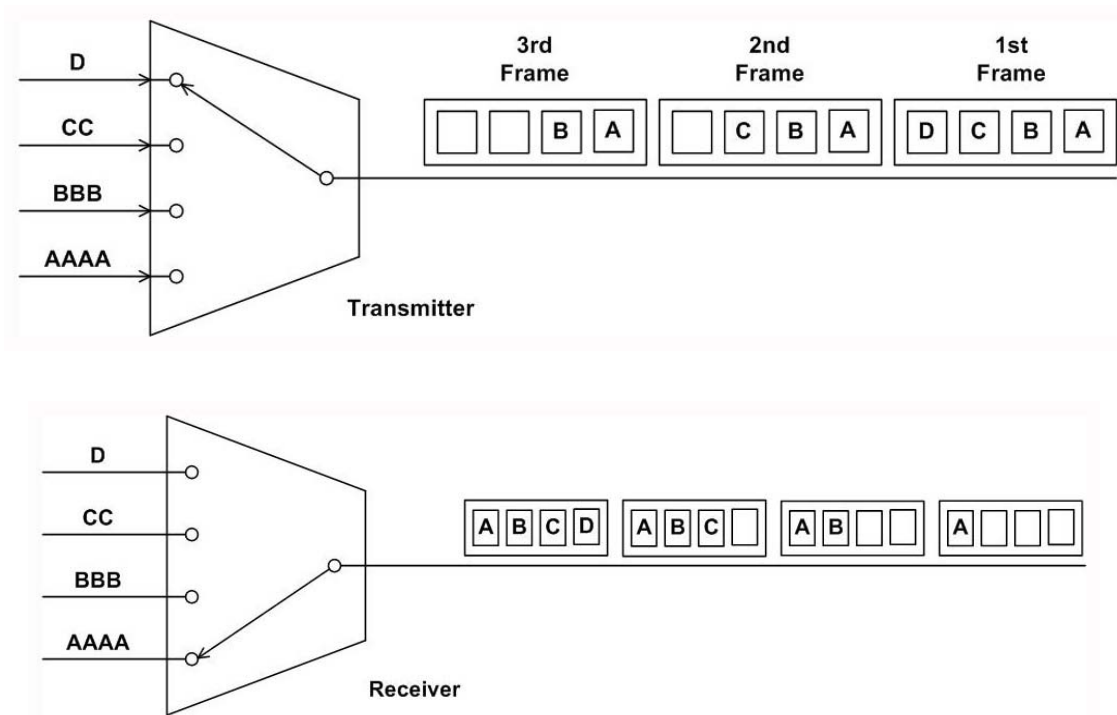

Figure 2.7.8 Multiplexing and demultiplexing in synchronous TDM

2.7.5 Statistical Time-division Multiplexing

One drawback of the TDM approach, as discussed earlier, is that many of the time slots in the frame are wasted. It is because, if a particular terminal has no data to transmit at particular instant of time, an empty time slot will be transmitted. An efficient alternative to this synchronous TDM is statistical TDM, also known as **asynchronous TDM** or **Intelligent TDM**. It dynamically allocates the time slots on demand to separate input channels, thus saving the channel capacity. As with Synchronous TDM, statistical multiplexers also have many I/O lines with a buffer associated to each of them. During the input, the multiplexer scans the input buffers, collecting data until the frame is filled and send the frame. At the receiving end, the demultiplexer receives the frame and distributes the data to the appropriate buffers. The difference between synchronous TDM and asynchronous TDM is illustrated with the help of Fig. 2.7.9. It may be noted that many slots remain unutilised in case synchronous TDM, but the slots are fully utilized leading to smaller time for transmission and better utilization of bandwidth of the medium. In case of statistical TDM, the data in each slot must have an address part, which identifies the source of data. Since data arrive from and are distributed to I/O lines unpredictably, address information is required to assure proper delivery as shown in Fig. 2.7.10.. This leads to more overhead per slot. Relative addressing can be used to reduce overhead.

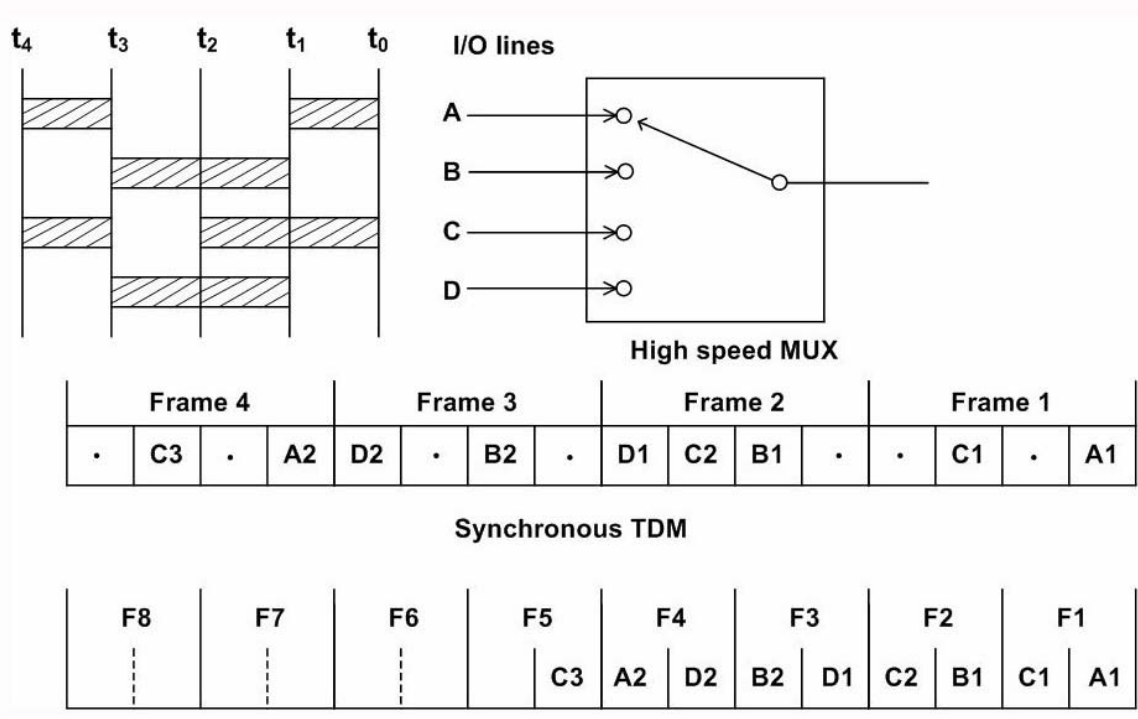

Figure 2.7.9 Synchronous versus asynchronous TDM

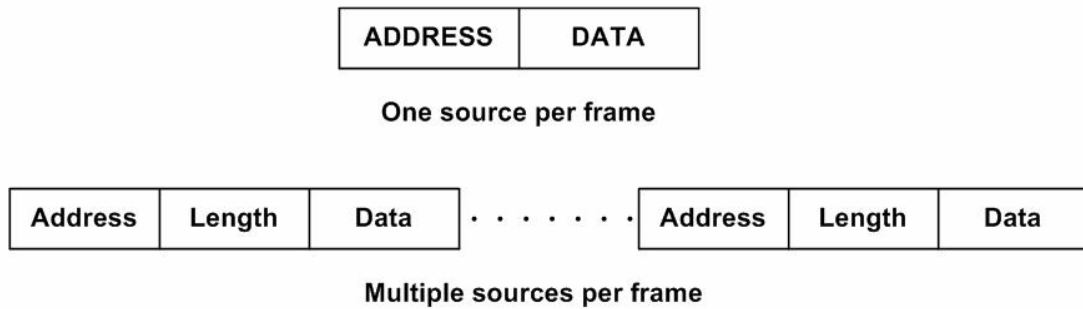

Figure 2.7.10 Address overhead in asynchronous TDM

2.7.6 Orthogonal Frequency Division Multiplexing

Frequency division multiplexing (FDM) is a technology that transmits multiple signals simultaneously over a single transmission path, such as a cable or wireless system. Each signal travels within its own unique frequency range (carrier), which is modulated by the data (text, voice, video, etc.).

Orthogonal FDM's (OFDM) spread spectrum technique distributes the data over a large number of carriers that are spaced apart at precise frequencies. This spacing provides the "orthogonality" in this technique, which prevents the demodulators from seeing frequencies other than their own. Basic approach of OFDM is illustrated in Fig. 2.7.11.

The benefits of OFDM are high spectral efficiency, resiliency to RF interference, and lower multi-path distortion. This is useful because in a typical terrestrial broadcasting scenario there are multipath-channels (i.e. the transmitted signal arrives at the receiver using various paths of different length). Since multiple versions of the signal interfere with each other (inter symbol interference (ISI)) it becomes very hard to extract the original information.

OFDM is a transmission technique that has been around for years, but only recently became popular due to the development of digital signal processors (DSPs) that can handle its heavy digital processing requirements. OFDM is being implemented in broadband wireless access systems as a way to overcome wireless transmission problems and to improve bandwidth. OFDM is also used in wireless LANs as specified by the IEEE 802.11a and the ETSI HiperLAN/2 standards. It is also used for wireless digital radio and TV transmissions, particularly in Europe. OFDM is sometimes called multi-carrier or discrete multi-tone modulation.

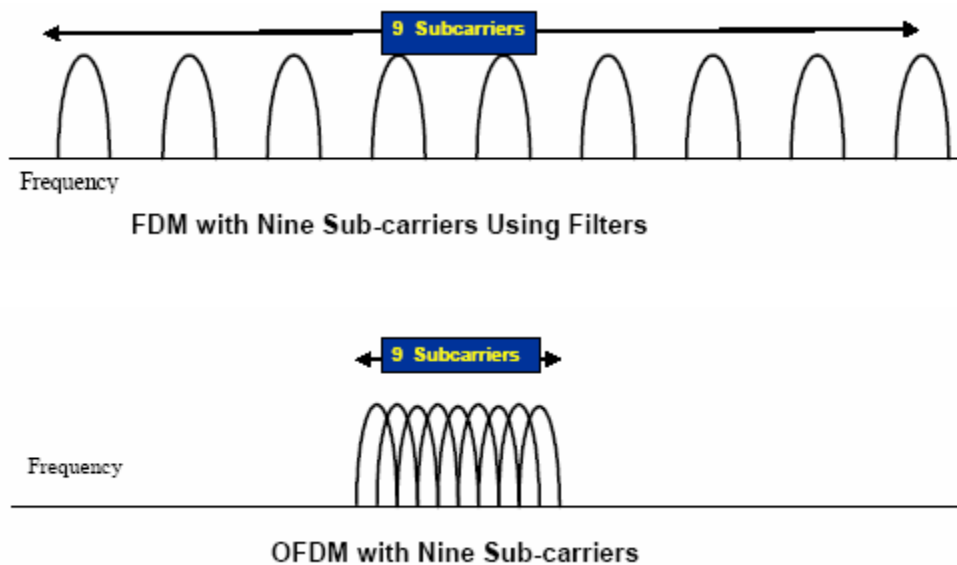

Figure 2.7.11 Difference between band-width requirements in FDM Vs OFDM

OFDM is similar to FDM but much more spectrally efficient by spacing the sub-channels much closer together (until they are actually overlapping). This is done by finding frequencies that are orthogonal, which means that they are perpendicular in a mathematical sense, allowing the spectrum of each sub-channel to overlap another without interfering

Fill in the blanks

- (a) _____ are used to reduce the inter-modulation distortion.
- (b) Multiplexing is essentially dividing the _____ of a channel into separate sub-channels...
- (c) Telephone system uses _____ multiplexing whereas Television broadcast system uses _____ multiplexing system.
- (d) Statistical Time Division Multiplexing is also called _____ TDM or _____ TDM.
- (e) Statistical TDM, also known as _____ TDM or _____ TDM.
- (f) Wave-division multiplexing (WDM) is conceptually the same as _____.

Short Answer Questions:

1. In what situation multiplexing is used?

Ans: Multiplexing is used in situations where the transmitting media is having higher bandwidth, but the signals have lower bandwidth. Hence there is a possibility of sending number of signals simultaneously. In this situation multiplexing can be used. Multiplexing can be used to achieve the following goals:

- To send a large number of signals simultaneously.
- To reduce the cost of transmission
- To make effective use of the available bandwidth
-

2. Distinguish between the two basic multiplexing techniques?

Ans:

The two basic multiplexing techniques are:

- Frequency division multiplexing (FDM)
- Time division multiplexing (TDM)

FDM can be used with analog signals. A number of signals are carried simultaneously on the same medium by allocating to each signal a different frequency band.

TDM (also known as synchronous time division multiplexing) can be used with digital signals or analog signals carrying digital data. In TDM, data from various sources are carried in respective frames. Each frame consists of a set of time slots, and each source is assigned a time slot per frame.

3. Why guard bands are used in FDM?

Ans: In FDM, a number of signals are sent simultaneously on the same medium by allocating separate frequency band or channel to each signal. Guard bands are used to avoid interference between two successive channels.

4. Why sync pulse is required in TDM?

Ans: In TDM, in each frame time slots are pre-assigned and are fixed for each input sources. In order to identify the beginning of each frame, a sync pulse is added at the beginning of every frame.

5. How is the wastage of bandwidth in TDM overcome by Statistical-TDM?

Ans: It dynamically allocates the time slots on demand to separate input channels, thus saving the channel capacity. As with Synchronous TDM, statistical multiplexers also have many I/O lines with a buffer associated to each of them. During the input, the multiplexer scans the input buffers, collecting data until the frame is filled and send the frame. At the receiving end, the demultiplexer receives the frame and distributes the data to the appropriate buffers.

In case of statistical TDM, the data in each slot must have an address part, which identifies the source of data.

6. What is the difference between Frequency Division Multiplexing and Wave Division Multiplexing?

Ans:

Wave-division multiplexing (WDM) is conceptually the same as FDM, except that the multiplexing and demultiplexing involves light signals transmitted through fibre-optic channels. The idea is the same: we are combining different frequency signals. However, the difference is that the frequencies are very high.

7. What is Orthogonal Frequency Division Multiplexing?

Ans: Orthogonal FDM's (OFDM) spread spectrum technique distributes the data over a large number of carriers that are spaced apart at precise frequencies. This spacing provides the "orthogonality" in this technique which prevents the demodulators from seeing frequencies other than their own.

The benefits of OFDM are high spectral efficiency, resiliency to RF interference, and lower multi-path distortion.

8. What limitation of TDM is overcome in ATM and how?

Ans: In TDM, each frame consists of a set of time slots, and each source is assigned one slot per frame. In a particular frame, if a source is not having data, then that time slot goes empty. As a result, many of the time slots are wasted.

This problem of TDM is overcome in ATM. In ATM, the time slots are not pre-assigned to a particular data source. Rather, slots are dynamically allotted to sources on demand, depending on the availability of data from different sources.