

# Chapter 31

## Channelization

### 31.1 Introduction

One of the most effective and efficient methods of controlling the traffic on a highway is the adoption of high intersection geometric design standards. Channelization is an integral part of at grade intersections and is used to separate turning movements from through movements where this is considered advisable and hence helps reduce the intensity and frequency of loss of life and property due to accidents to a large extent. Proper Channelization increases capacity, improves safety, provides maximum convenience, and instils driver confidence. Improper Channelization has the opposite effect and may be worse than none at all. Over Channelization should be avoided because it could create confusion and worsen operations.

### 31.2 Definitions and Important Terms

1. **Channelization** - It is the separation or regulation of conflicting traffic movements into definite paths of travel by traffic islands or pavement marking to facilitate the safe and orderly movements of both vehicles and pedestrians.
2. **Conflict** - It is defined as the demand for the same highway space by two or more users of the highway. Conflicts are classified into mainly three types:
  - (a) Crossing conflicts
  - (b) Diverging conflicts
  - (c) Merging conflicts
3. **Angle of Intersection** - The angle of intersection is that formed by the centerlines of the intersecting streets. Where the angle of intersection departs significantly (more than approximately  $20^\circ$ ) from right angles, the intersection is referred to as a skewed

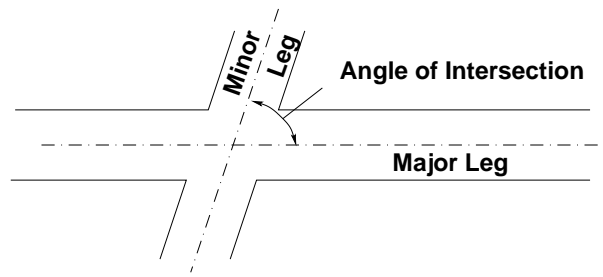

Figure 31:1: Angle of Intersection

intersection. Fig. 31:1 shows the angle made between the center lines of the major and minor legs.

4. **Refuge Areas** - The area which is used to give refuge to the pedestrians crossing a street (the open area between two medians) is known as a refuge area.

### 31.3 Objectives

The use of Channelization is often creative and innovative, providing for vehicle path separation and distinct and thus in general making traffic flow safer, smoother, simpler and efficient. The main objectives of Channelization can be summarized as follows:

1. **Separation of maneuver areas:** The drivers should be presented with only one decision at a time to reduce confusion and the influence of operations caused due to the overlapping of maneuver areas.
2. **Reduce excessively large paved areas:** The spread of the paved area can be considerably reduced by the construction of raised islands and medians where these are considered safe and necessary.
3. **Control of maneuver angle:** The intensity of accidents can be reduced to a large extent by providing small angles for merging, diverging and weaving (at low relative speeds) and approximately right angles for crossing (at high relative speeds). The maneuver angle can be easily controlled by constructing islands of appropriate shapes and sizes.
4. **Favor predominant turning movements:** Channelization is also directed for giving preference to turning movements at an intersection where the proportion of such traffic is high.

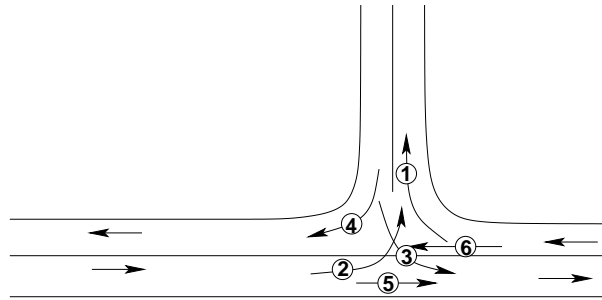

Figure 31:2: Illustration of T-intersection Channelization, (a) Intersection with no Channelization

5. **Control of speed:** Channelization is also used for supporting stop or speed regulations by removing differentials in speed for merging, diverging, weaving and crossing by using the bending and funneling techniques.
6. **Protection and storage of turning and crossing vehicles:** To shadow slow or stopped vehicles from other traffic flows.
7. **Blockage of prohibited movements:** Proper Channelization also helps maintain traffic regulations by making prohibited movements impossible or inconvenient.
8. **Provide space for traffic control devices:** To provide space for traffic control devices when the ideal location for the same is within the intersection area.
9. **Segregation of non-homogeneous flows:** Channelization provides separate channels for turning and through, fast and slow, and opposite direction traffic.
10. **Protection of pedestrians and reduction of crossing distances between refuges:** Non-traversable and wide medians provide a refuge for pedestrians crossing a street.

Consider for example the T-intersection shown in Figs. 31:2, 31:3, and 31:4. In Fig. 31:2, the intersection has no special Channelization for helping drivers in avoiding conflicts between movements. In Fig. 31:3, a passing lane for through vehicles in the eastbound direction and a westbound right-turn lane has been added, which helps in separating the turning traffic from the through ones. In Fig. 31:4, the use of lanes is further clarified due to the addition of channelizing islands.

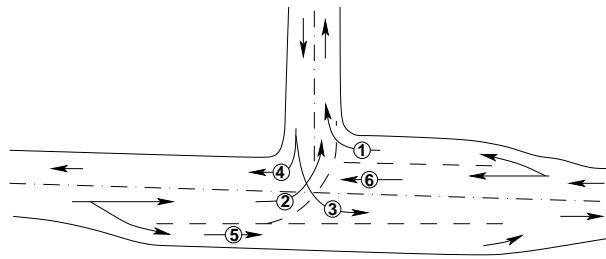

Figure 31:3: Illustration of T-intersection Channelization, (b) Intersection with right-turn and passing lane

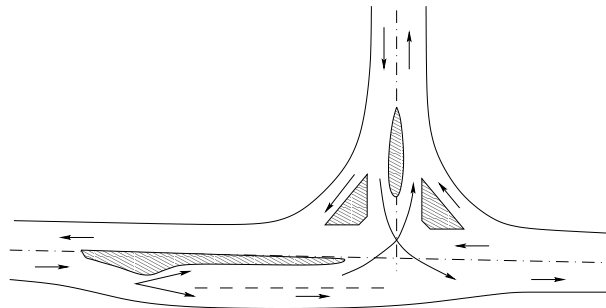

Figure 31:4: Illustration of T-intersection Channelization, (c) Fully channelized intersection

## 31.4 Design Principles

Design of a channelized intersection usually involves the following significant controls: the type of design vehicle, the cross sections on the crossroads, the projected traffic volumes in relation to capacity, the number of pedestrians, the speed of vehicles, and the type and location of traffic control devices. Furthermore, the physical controls such as right-of-way and terrain have an effect on the extent of Channelization that is economically feasible.

The degree to which each of these principles applies will depend upon the features mentioned above. While a principle may be modified in its application to a particular site, disregard of these may result in a hazardous design. The principles may be summarized as follows:

1. **Reduction of the Area of Conflict:** The impact area is decreased when Channelization is provided, and hence the probability of conflicts is also reduced. The figure below further clarifies the statement. Fig. 31:5 shows the conflict area in a Y-intersection without Channelization and Fig. 31:6 shows the reduced conflict area in the same intersection after providing medians.
2. **Merging traffic streams at small angles:** Merging at small angles permits the flow of traffic streams with minimum speed differentials. Hence, the gap acceptance time is

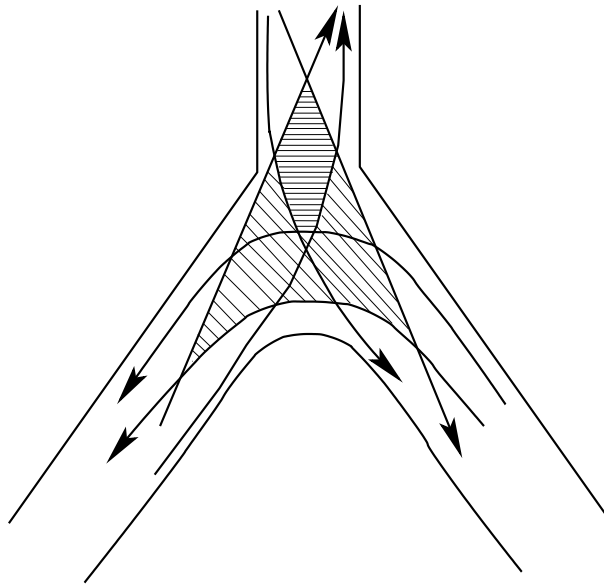

Figure 31:5: Conflict area in all paved intersection

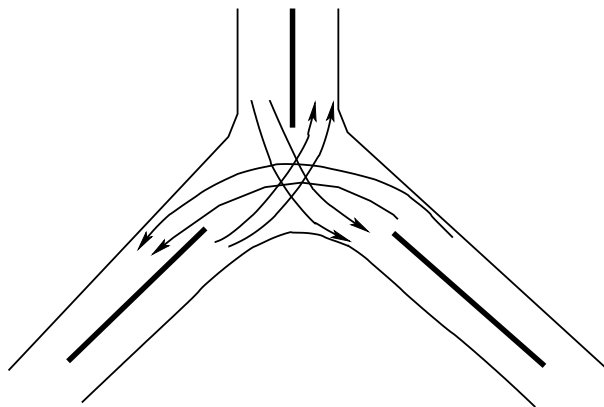

Figure 31:6: Conflict area in a channelized intersection

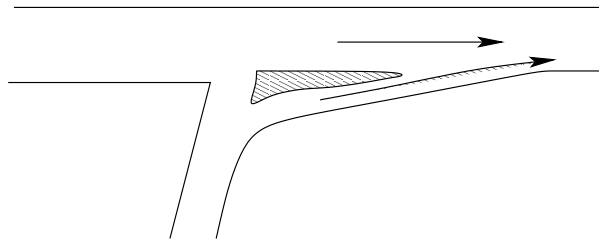

Figure 31:7: Merging of traffic streams

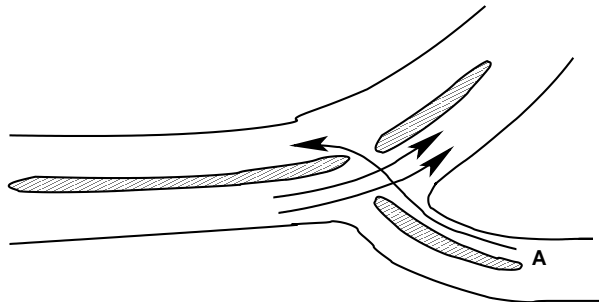

Figure 31:8: Bending path of incoming minor street

also small in such cases. The merging of roadways should be done as shown below in Fig. 31:7.

3. **Reduction of the speed of incoming traffic by bending its path:** The speed of vehicles entering into the intersection can be reduced by bending the path to the intersection approach. However as far as possible the path of the major traffic stream should not be bent. The above technique is shown below in Fig. 31:8.
4. **Reduction of speed of traffic by funneling:** The funneling technique can also be used for reducing the speeds of the incoming vehicles. Due to the decrease in the width of the lane at the approach, the drivers tend to reduce the speed of their vehicles near the intersection. Fig. 31:9 shows the funneling technique used for reduction of speed.
5. **Protection for turning vehicles/crossing conflicting traffic streams:** Provision of a refuge area between the two opposing streams allows the driver of a crossing vehicle to select a safe gap in one stream at a time and also provides a safer crossing maneuver. Fig. 31:10 further clarifies the above statement.
6. **Discourage prohibited turns by island placement and shape:** Undesirable and prohibited turns can be discouraged by the proper selection of shape and location of the

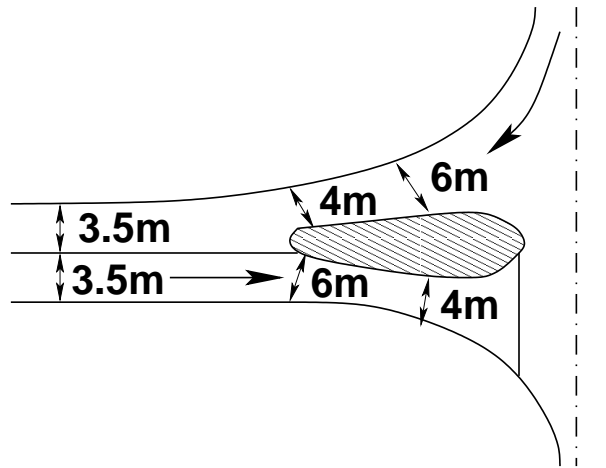

Figure 31:9: Reduction of speed by funneling

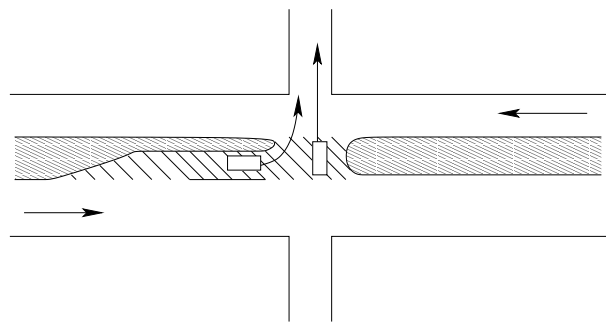

Figure 31:10: Refuge area for protecting crossing or turning traffic

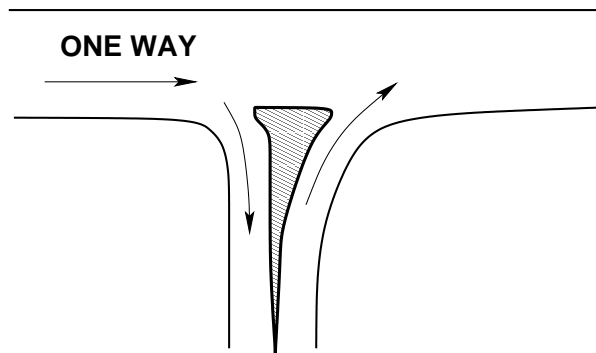

Figure 31:11: Properly placed islands discourage prohibited movements

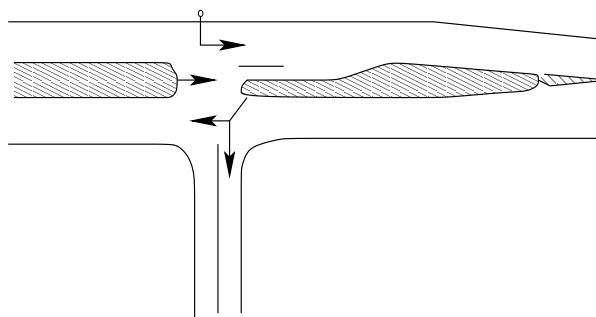

Figure 31:12: Location of signal posts on medians at intersections

islands. Fig. 31:11 shows how prohibited turns can be discouraged by proper shaping and placement of islands.

7. **Providing locations of traffic control devices:** Channelization may provide locations for the installation of essential traffic control devices, such as stop and directional signs, signals etc. Fig. 31:12 shows how channelizing devices can also be used for locating traffic control devices.

## 31.5 Channelizing devices

A channelizing device can be defined as any structure which helps in providing Channelization. These can be wide raised medians, non-traversable road islands, traversable raised curbs or even flush channelizing devices. A brief description of the various devices which are used for the purpose of Channelization are given in the following sections.

### 1. Wide Raised Medians

In this form of channelizing device, a raised wide separator is constructed between the



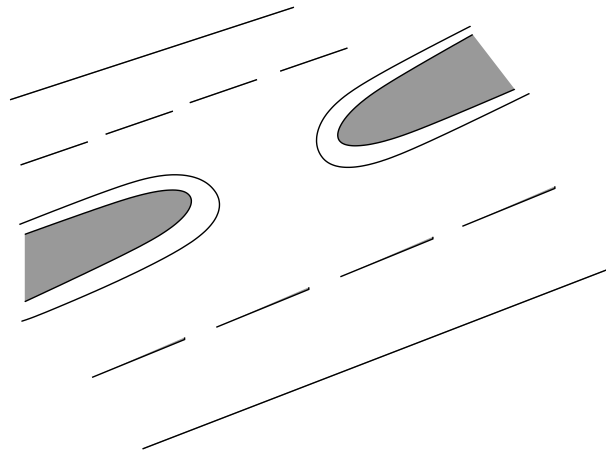

Figure 31:13: Wide raised median

two opposing lanes and the space on the separator (median) is used either for planting some trees and/or for providing space for traffic signs etc. Fig. 31:13 shows a typical wide raised median on a freeway. A median varying between 1.2 m and 30 m in width may be employed. The higher values of width are adopted on freeways, where sufficient space is available for the construction of these. In addition, a well-landscaped wide median will also provide aesthetic benefits to the surrounding neighborhood. A wide median, if attractively landscaped, is often the most aesthetically pleasing separation method.

## 2. Non- traversable Raised Islands

In this type of device, a narrower and a higher median than the traversable island is constructed between the opposing lanes. This class of device has the advantage of a narrower median, but its use should be restricted to approach roadways with vehicle speeds of 60 kmph or below. These are generally 15 to 20 cm high and about 60 cm in width. Due to the height, most of the vehicles are not able to cross the median, and hence the name. Fig. 31:14 shows a non-traversable raised island constructed on a roadway. These devices are substantial enough that each installation should be carefully designed, as an inappropriately placed median can constitute a hazard if struck by an errant vehicle and hence the severity and crash risk is highly increased on the roadways having non-traversable raised islands.

## 3. Traversable Raised Curb Systems

In this device, a narrow and mountable type of raised curb is constructed to separate the traffic moving in the opposing lanes. This class of channelizing device is the narrowest, and therefore the easiest to fit in a wide range of roadway cross-section widths. The curb

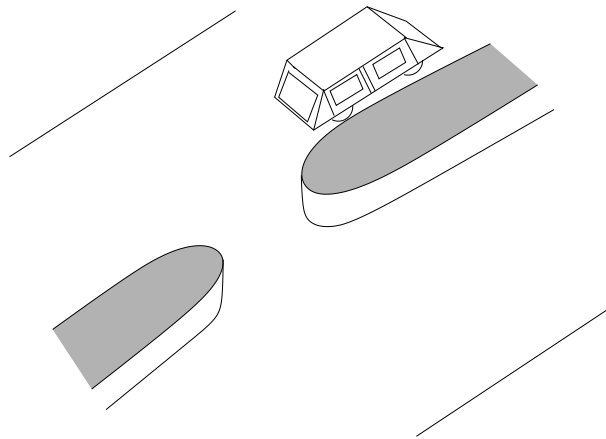

Figure 31:14: Non-traversable Raised Island (source: [13])

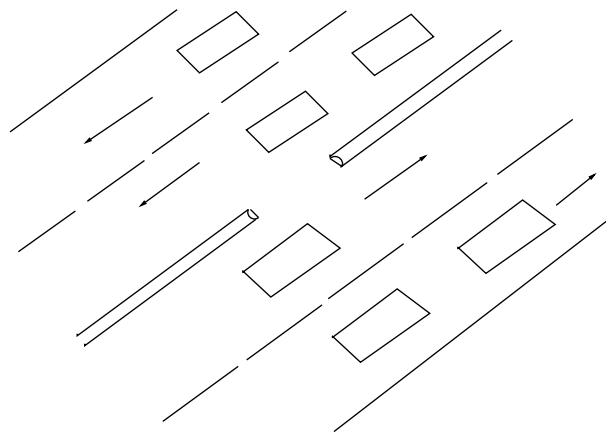

Figure 31:15: Traversable Raised Curb System (without vertical panels)

is up to 10 cm in height and up to about 30 cm in width. Curbs are formed with a rounded shape that will create minimal vehicle deflection upon impact. Generally, it is used with reboundable, reflectorized vertical panels to provide a visual deterrent to the drivers to cross over to opposite traffic lane. The main advantage of this type of device is that it can be installed on existing roadway centerlines, without the need for widening the roadway approaches to the crossing. Figs. 31:15 and 31:16 shows traversable raised curbs with and without vertical panels.

**4. Flush Channelization**

In this type of Channelization, a variety of treatments, including raising them above the pavement just slightly (2 to 5 cm); the application of pavement markings and other types of contrasting surfaces etc are possible. These may also be unpaved where they are

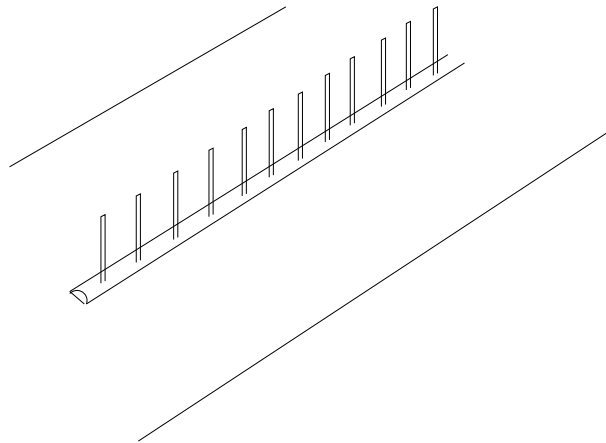

Figure 31:16: Traversable Raised Curb System (with vertical panels)

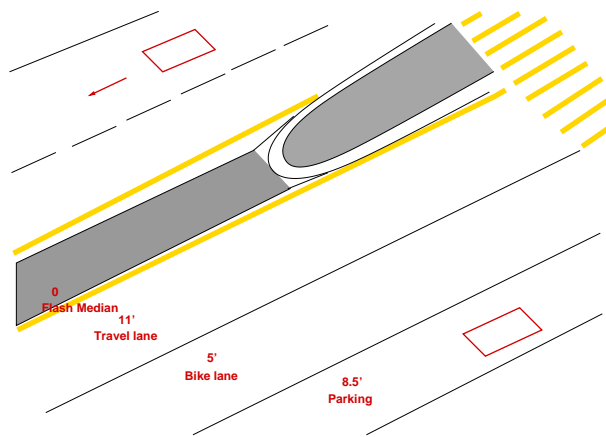

Figure 31:17: Flush island providing Channelization objectives

formed by the pavement edges of existing roadways. In areas where snow plowing may be necessary, flush islands are the preferred design. Fig. 31:17 below shows how flush islands can also be used for achieving channelizing objectives. The area seen flushed with the road surface in Fig. 31:17 is the flush island.

### 31.6 Traffic Islands

A principle concern in Channelization is the design of the islands. An island is a defined area between traffic lanes for control of vehicle movements. Within an intersection area, a median or an outer separation is considered to be an island. It may range from an area delineated by barrier curbs to a pavement area marked by paint.

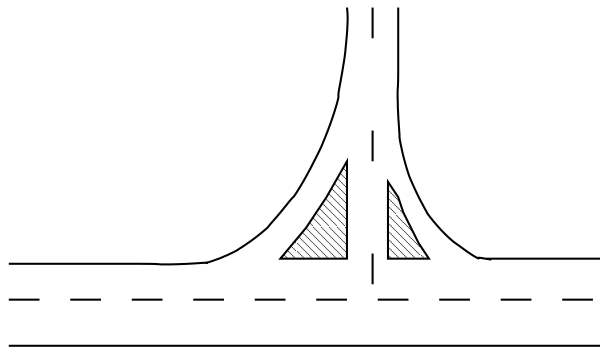

Figure 31:18: Channelizing Islands

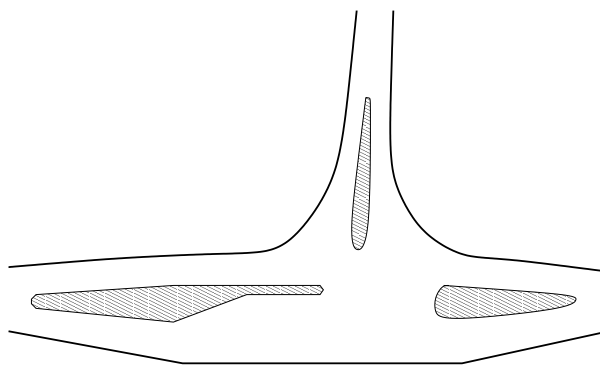

Figure 31:19: Divisional Islands

### 31.6.1 Classification of Islands

Traffic islands usually serve more than one function, but may be generally classified in three separate types:

1. **Channelizing Islands** - These are designed to control and direct traffic movement, usually turning. Channelizing islands are shown in Fig. 31:18.
2. **Divisional Islands** - These are designed to divide opposing or same direction traffic streams, usually through movements. Fig. 31:19 shows the placing of divisional islands in a roadway.
3. **Refuge islands** - Pedestrian islands are provided to serve as safety zones for the aid and protection of persons on foot. If a divisional island is located in an urban area where pedestrians are present, portions of each island can be considered a refuge island. Refuge islands are shown below I Fig. 31:20. The design aspects of the traffic islands are dealt in detail in the following sections.

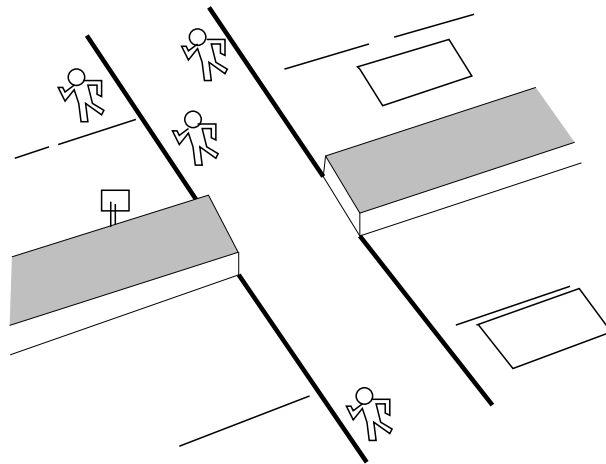

Figure 31:20: Refuge Islands

### 31.6.2 Design Considerations for Traffic Islands

The necessity for an island should be determined only by careful study, since it is placed in an area that would otherwise be available for vehicular traffic. The island design should be carefully planned so that the shape of the island will conform to natural vehicular paths and so that a raised island will not constitute a hazard in the roadway. A judiciously placed island at an intersection on a wide street may eliminate the need for traffic signal control by channelizing traffic into orderly movements. The total design of traffic islands can be studied in three steps:

- 1. Selection of appropriate island type (barrier, mountable, painted or flush):** The site and traffic conditions in each intersection are different and hence the island type suitable for each requires separate attention. The traffic island selected may vary from barrier type islands to flush islands marked on the roadway surface.
- 2. Determination of shape and size of islands:** The shape of the island and its size in an intersection depends on the geometry and space availability at the same. A proper shape and size of the island (in case of raised islands) must be selected so that it is able to both channelized the traffic and not pose any type of hazard.
- 3. Location relative to adjacent traffic lanes:** The islands must be offset from the roadway by some distance to remove the risk of a vehicle dashing against the same. The width of offset is maximum at the entry of the island and decreases gradually as one moves towards the end of it.

### 31.6.3 Guidelines for selection of island type

As mentioned earlier, each intersection has a unique geometry and flow values, and hence needs special attention as far as the use of Channelization devices are concerned. The main factors affecting the selection of the island type are:

1. Traffic characteristics at the intersection
2. Cost considerations, and
3. Maintenance needs

The raised islands and flush Channelization are dealt with in details in the following sections.

#### Flush Channelization

Flush Channelization is usually appropriate in the following conditions:

1. On high speed rural highways to separate turning lanes.
2. In constrained locations, i.e. the locations where vehicle path definition is desired but space for raised islands not available.
3. For separating opposing traffic streams of low speed streets.
4. In areas where frequent removal of snowfall is required, i.e. in places of high snow fall.
5. It can also be used as a temporary Channelization either during construction or to test traffic operations prior to the actual installation of raised islands.

However, the main demerits of this type of Channelization are :

1. It is not effective in prohibiting or preventing traffic movements.
2. It is also not appropriate for islands intended to serve as pedestrian refuge.

#### Raised Islands

The locations where the construction of raised islands assumes importance are:

1. The primary function of the channelizing device is shielding pedestrians or to provide refuge to pedestrians crossing a street.
2. Also, the primary/secondary function is locating traffic signals or other fixed objects.

Table 31:1: Flush Channelization vs Raised Channelization

<b>FLUSH CHANNELIZATION</b>	<b>OPERATING CONDITIONS</b>
1. For Right turns	High Speeds
2. To provide temporary or trail Channelization	Rural highway
3. To shadow left turns	Minor urban intersections
<b>RAISED CHANNELIZATION</b>	<b>OPERATING CONDITIONS</b>
1. Post signs or signals	Urban streets
2. Provide pedestrian refuse	Low speeds
3. Prevent wrong way movements	High volumes

3. Intention is to prohibit or prevent certain traffic movements.
4. To separate high volume opposing traffic flows.
5. The raised islands are also particularly important at intersections with unusual geometry i.e. skewed intersections.

A comparison between the usefulness and the operating conditions of the two types of Channelization is presented in Table. 31:1.

### 31.6.4 Guidelines for design of Traffic Islands

The main design principles followed for the design of the shape and size and shape of the traffic island are as follows:

1. **Shape and size:** Islands are generally either narrow and elongated or triangular in shape, are normally situated in areas of the roadway outside the planned vehicle paths, and are shaped and dimensioned as component parts of the street or intersection layout. The actual size differs as governed by site conditions, but the following minimum size requirements should be met to insure that the island will be large enough to command attention.
2. Traffic lanes or turning roadways should appear natural and convenient to their intended users.
3. Number of islands should be held to a practical minimum to avoid confusion.
4. The islands should be large enough to be effective. Small islands do not serve as channelizing devices and pose maintenance problems.

Table 31:2: Recommended Island Sizes

Location of Intersection	Size(Sq.meters)	
	Minimum	Desired
Urban	4.65	7
Rural and High Speed urban/Suburban	7	9.3

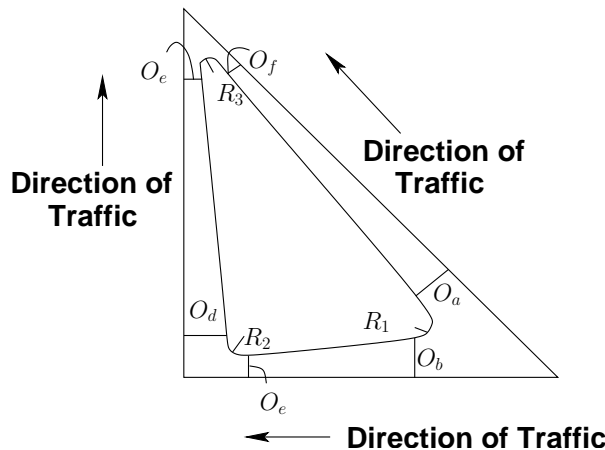

Figure 31:21: Recommended Offset Dimensions for location of Traffic Islands

- 5. These should not be introduced at locations with restricted sight distance or middle of sharp horizontal curves due to sight distance considerations.

Table. 31:2 gives the recommended minimum and desired area values of the traffic islands in typical urban and rural intersections.

### 31.6.5 Guidelines for providing offset to the traffic islands from the road edge

The orientation of islands near intersections is dictated by the alignment of the intersecting roadways and their associated travel paths. Proper island design must minimize the potential for vehicle impacts and reduce their severity. This is most often accomplished by offsetting the approach ends of islands from the edge of travel lane them, tapering them inward. Another technique that is the use of rounded approach noses that may also be sloped downward on their approach ends. The general design dimensions of corner islands for roadways in shown in Fig. 31:21. Another design consideration for islands is their surface finishing. Islands may be paved or landscaped. Though paved islands are easier to maintain, yet they are typically not as aesthetically pleasing. The use of colors that have contrast with the pavement surface is



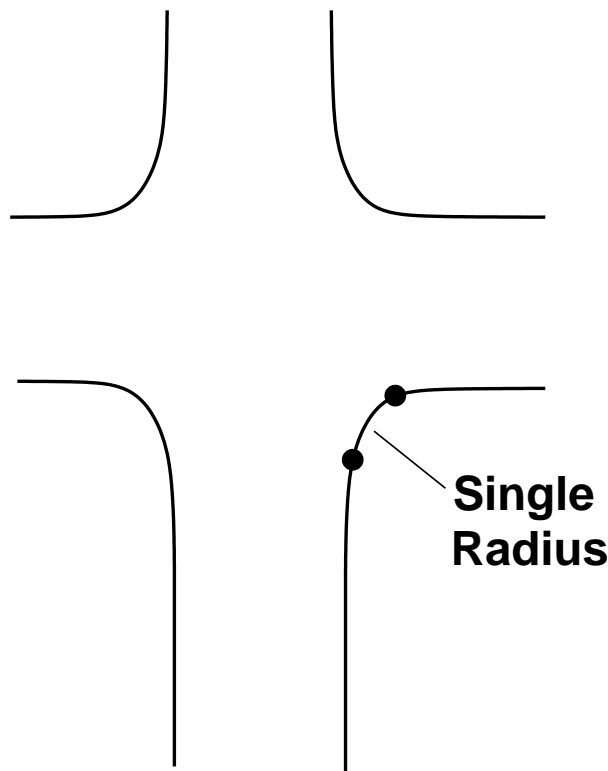

Figure 31:22: Various types of curves used for a turning roadway , (a)Simple Radius

desirable because they allow the island to be more clearly seen by drivers. Normally concrete islands are paired with asphalt roadways and vice versa. Brick paver are also used in areas where aesthetics are important. Other concerns include the need to provide adequate slope to the surface of the island to facilitate drainage and to keep the island free of sight obstructions and collision. Thus, all landscaping features should be kept below the clear vision envelop and should not incorporate other fixed hazards.

### Curve/taper combinations for turning roadways and islands

The combination of a simple radius flanked by tapers can often fit the pavement edge more closely to the design motor vehicle than a simple radius (with no tapers). Figs. 31:22, 31:23 and 31:24 shows the various types of curves that can be used for a roadway. The closer fit can be important for large design motor vehicles where effective pavement width is small (due either to narrow pavement or need to avoid any encroachment), or where turning speeds greater than the design speed are desired. Table. 31:3 and Table. 31:4 summarizes design elements for curve/taper combinations that permit various design motor vehicles to turn, without any encroachment, from a single approach lane into a single departure lane (Note: W should be

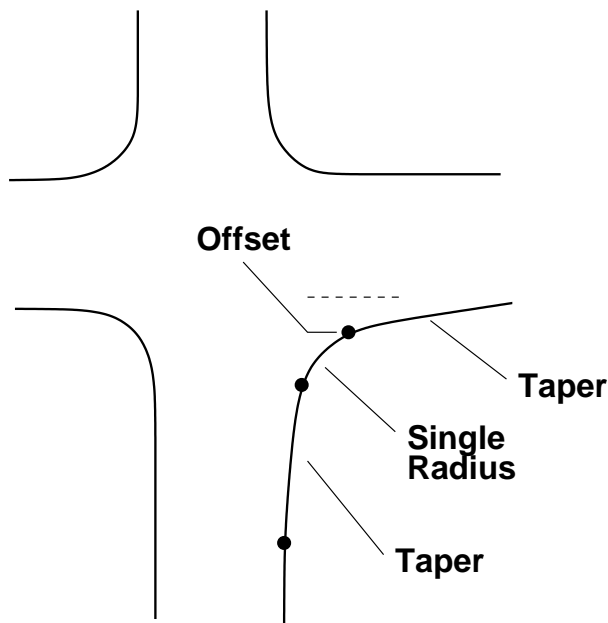

Figure 31:23: Various types of curves used for a turning roadway, (b)Radius and Taper

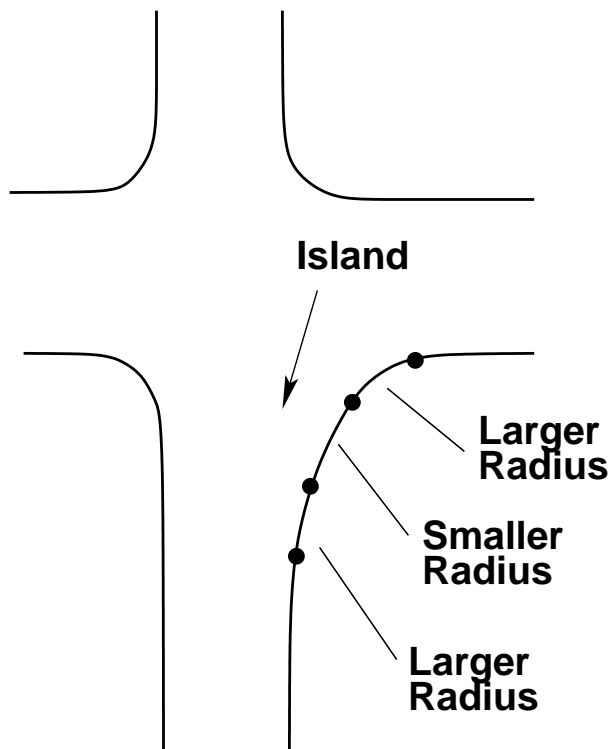

Figure 31:24: Various types of curves used for a turning roadway, (c)Turning Roadway

Table 31:3: Curve and Taper Corner Design Elements

Angle of Turn (Degrees)	Design Vehicle	Radius (meters)	Offset (OS meters)	Taper Length (T1 meters)
75	Passenger Car	7.5	0.6	6
	Single Unit Truck	13.5	0.6	6
	Single Trailer Unit	19.5	0.9	13.5
90	Passenger Car	6	0.75	7.5
	Single Unit Truck	12	0.6	6
	Single Trailer Unit	18	1.2	18
120	Passenger Car	6	0.6	-
	Single Unit Truck	9	0.9	-
	Single Trailer Unit	13.5	1.2	18

determined using the turning path of the design vehicle) The width of the roadway can be found out from Table. 31:5 given below.

### 31.7 Guidelines for design of Median islands

The general guidelines to be followed in the design of median islands (separators of opposing traffic flows) are:

1. The approach noses should be offset 0.6 to 1.8 m from through lanes to minimize accidental impacts.
2. Shape should be based on design turning paths and island function. (Generally parabolic or circular arcs are used)
3. The length of median before the intersection is related to approach speed (normally 3 sec driving time to intersection). It is also affected by available widths, taper designs and local constraints.
4. The width of the medians should serve its primary intended function.
5. The median should always be provided well past crest vertical curves.

Fig. 31:25 shows the general design elements of medians provided just at the approach to a intersection. The required median widths for performing their intended functions are provided

Table 31:4: Design elements for Turning Roadways

Angle of Turn (Degrees)	Design Vehicle	Radius(meter) R1-R2-R1	Offset (OS meter)
75	Passenger Car (P)	30-22.5-30	0.6
	Single Unit Truck (SU)	36-13.5-36	0.6
	Semi-Trailer Unit (WB-50)	45-15-45	2
90	Passenger Car (P)	30-6-30	0.8
	Single Unit Truck (SU)	36-12-36	0.6
	Semi-Trailer Unit (WB-50)	54-18-54	2
120	Passenger Car (P)	30-6-30	0.6
	Single Unit Truck (SU)	30-9-30	0.9
	Semi-Trailer Unit (WB-50)	54-12-54	2.6

Table 31:5: Width of roadway required for negotiating the turn for different classes of vehicles (W)

Radius on inner edge of pavement in meter	One-Lane One Way Operation (No provision of passing a stalled vehicle) in meter			One-Lane One Way Operation (Having provision of passing a stalled vehicle) in meter			Two way operation Either One way or Two way (Same Type of vehicle in both lanes) in meter		
	P	SU	WB-50	P	SU	WB-50	P	SU	WB-50
15	3.9	5.4	7.8	6	8.7	13.2	7.8	10.5	15
22.5	3.9	5.1	6.6	5.7	8.1	10.8	7.5	9.9	12.6
30	3.9	4.8	6.3	5.7	7.5	10.2	7.5	9.3	12
45	3.6	4.8	5.7	5.4	7.2	8.7	7.2	9	10.5
60	3.6	4.8	5.1	5.4	6.9	8.1	7.2	8.7	9.9
90	3.6	4.5	5.1	5.4	6.6	7.5	7.2	8.4	9.3

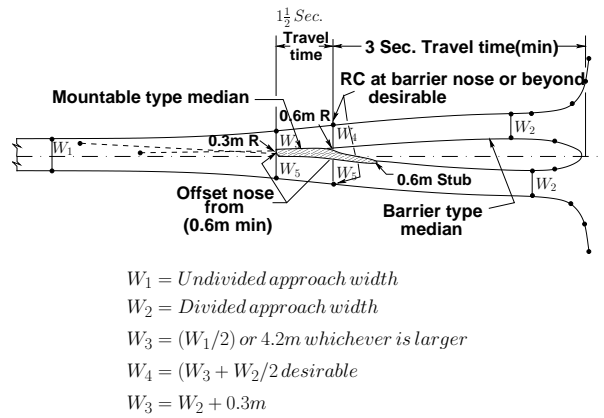

Figure 31:25: Design Criteria for raised median approaches to intersections

Table 31:6: Basic median functions and their required width

Function	Width in meter	
	Minimum	Desirable
Separation of opposing traffic	1.2	3
Provision of pedestrian refuse	1.8	4.2
Provision of storage for left-turn vehicles	4.8	6
Provision for protection of vehicles crossing through lanes	7.5	9
Provision for U turns, inside to outside lanes	4.8	6
Provision for U-turns, inside to inside lanes	7.8	9

by AASHTO and are shown in Table. 31:6 below. These widths are empirical and can be applied at an intersection with reasonable efficiency.

### 31.7.1 Auxiliary Lanes

Auxiliary lanes are used under conditions of relatively high traffic volumes in the intersections. In these cases, traffic congestion problems can be significantly alleviated with auxiliary lanes to handle turning movements. The median lane should be 12 feet (3.6m), but not less than 10 feet (3.0m) wide and should be clearly marked for this purpose.

Auxiliary lanes can also be introduced to provide for both left turns and right turns at intersections. The need for such lanes is determined by capacity analysis and the acceptable level of service designated for the facility. The lanes should be at least 2.7m wide for reconstruction and resurfacing projects and at least 3.0m, preferably 3.6m for new construction projects. Auxiliary

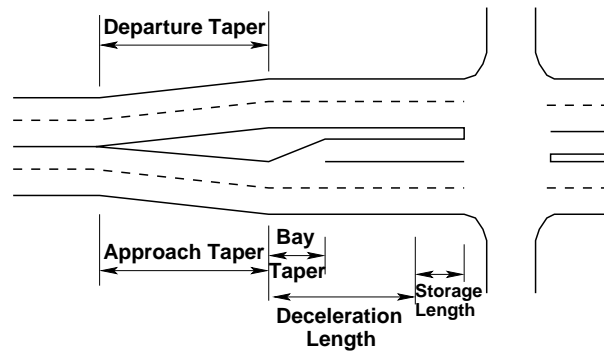

Figure 31:26: Components of Auxiliary Lane

lane shoulders can be reduced to 0.6 m wide on rural sections and 0 m wide on sections with curb and gutter. The length of auxiliary lanes consists of five components:

1. Approach Taper
2. Deceleration Length
3. Bay Taper
4. Storage Length, and
5. Departure Taper.

A typical auxiliary lane with the components are shown in Fig. 31:26 below. These are discussed in detail in the following section.

1. **Approach Taper-** The length of the approach taper varies with operating speeds. Guidelines for determining lengths are: (i) For speeds 70 kmph and over:  $L = 0.6WS$ , and (ii) For speeds under 70 kmph:  $L = WS^2/100$  where,  $L$  is the length of entering taper in m,  $W$  is the width to be tapered in m, and  $S$  is the operating Speed in kmph.
2. **Deceleration Length-** The deceleration length is that required for a comfortable stop of a vehicle from a speed that is typical of the average running speed on the facility. The Bay Taper can be considered part of the deceleration length. AASHTO has again given a table for calculating the decelerating length value from the design speed value (Table. 31:7).
3. **Bay Taper -** This is a straight line taper with ratios varying from 5:1 to 10:1. Higher speed facilities should generally have longer tapers. Empirically, the minimum and maximum values of bay taper are taken as 18m and 36m respectively.

Table 31:7: Deceleration length vs Design Speed

Design Speed (kmph)	Deceleration Length (m)
40	35
55	45
65	55
70	65
80	95

Table 31:8: Criteria for selection of median end shape

Effective Median Width	Median End Shape
Less than 3m	Semi-circular
3m - 20m	Bullet Nose
Over 20m	Treated as a separate intersection

4. **Storage Length** - The storage length should be sufficiently long to store the number of vehicles likely to accumulate during the average daily peak period.
  - (a) At unsignalized intersections, length to be based on the number of vehicles likely to arrive in an average 2-minute period within the peak hour.
  - (b) At signalized intersections, the required length depends on the signal cycle length, the signal phasing arrangement and the rate of arrivals and departures of left turning vehicles.
5. **Departure Taper** - The departure taper is normally taken equal in length to that of the approach taper and should begin opposite the beginning of the Bay Taper.

### 31.7.2 Shape of Median Ends

Generally, two types of end shapes are used in practice:-semicircular shapes and bullet nose. The shape adopted normally depends on the effective median width at the end of the median. The dimensions of the various parameters for semi-circular and bullet nose ends area as: Semi-circular-  $L = 2 \times ControlR$ ,  $R1 = M/2$ . Bullet-nose-  $L = ControlR$ ,  $R1 = M/2$ ,  $R2 = M/5$ . The criteria for the selection of median end is as given below in Table. 31:8. The two shapes

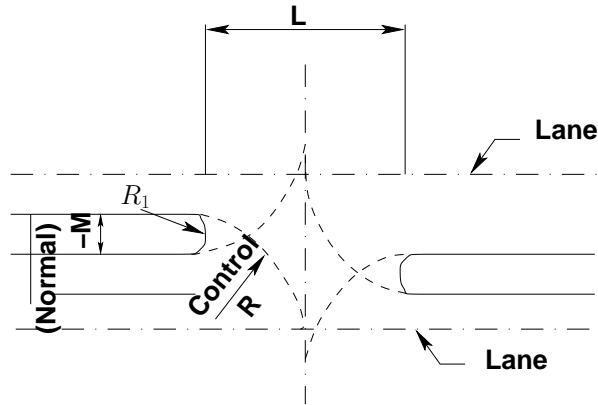

Figure 31:27: Shapes of Median ends, (a)Semi-circular

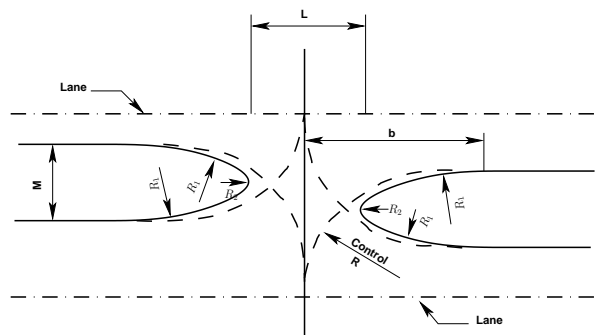

Figure 31:28: Shapes of Median ends, (b)Bullet-nose



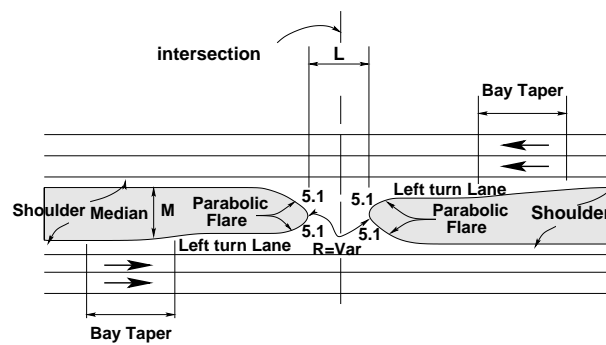

Figure 31:29: Intersection Median Opening

are illustrated in Figs. 31:27 and 31:28. The designer should evaluate each intersection to determine the best median opening shape that will accommodate the design vehicle.

### 31.7.3 Design of Median Openings

Median openings, sometimes called crossovers, provide for vehicular crossings of the median at designated locations. The design of a median opening should be based on traffic volumes and types of turning vehicles. Cross and turning traffic must operate in conjunction with the through traffic on the divided highway. This requirement makes it necessary to know the volume and composition of all movements occurring simultaneously during the design hours. The design of a median opening becomes a matter of considering what traffic is to be accommodated, choosing the design vehicle to use for layout controls for each cross and turning movement, investigating whether larger vehicles can turn without undue encroachment on adjacent lanes and, finally, checking the intersection for capacity. If the capacity is exceeded by the traffic load, the design must be expanded, possibly by widening or otherwise adjusting widths for certain movements. Traffic control devices such as yield signs, stop signs or traffic signals may be required to regulate the various movements effectively and to improve the efficiency of operations. Median openings at close intervals on other types of highways create interference with fast through traffic. Median openings should be spaced at intervals no closer than 500 m. However, if a median opening falls within 100 m of an access opening, it should be placed opposite the access opening. Also, the length of median opening varies with width of median and angle of intersecting roads. Fig. 31:29 shows the intersection median opening. The median openings for the different classes of design vehicle are as given in the Table. 31:9.

Table 31:9: Median Openings

Width of Median(m)	Passenger Car		Single Unit Truck		Single Trailer Unit	
	Semi - circular	Bullet nose	Semi - circular	Bullet nose	Semi - circular	Bullet nose
1.2	22.8	22.8	28.8	28.8	43.8	36.6
1.8	22.2	18	28.2	22.8	43.2	34.5
2.4	21.6	15.9	27.6	20.4	42.6	33
3	21	14.1	27	18.6	42	31.5
3.6	20.4	12.9	26.4	17.4	41.4	30
4.2	19.2	12	25.8	15.9	40.8	28.8
4.8	18	12	25.2	15	40.2	27.6
6	16.8	12	24	13.2	39	25.5

### 31.8 Developing a Channelization Plan

1. Channelization is more of an art rather than science. Every intersection requires a special study because of variations in physical dimensions, turning movements, traffic and pedestrian volumes, type of traffic control etc.
2. In the next step several island configurations are considered and compared. Then a choice is made between curbed, raised islands and flush Channelization or pavement markings.
3. Next it must be checked that the design is compatible to handle turning movements of large vehicles. Also, it should be such that the vehicles are guided in normal wheel paths, so that the island does not create an obstruction in the roadway.
4. Signing and marking are redesigned to guide drivers and avoid confusion.
5. The final plan includes details of civil and electrical engineering features (like drainage facilities, curbs, lighting, signals etc.) required for the project completion.

### 31.9 Typical Channelization Examples

Some typical Channelization ways used in practice are as given below. Figs. 31:30 to 31:41 indicate both normal Channelization and high type Channelization techniques for various intersections and situations.

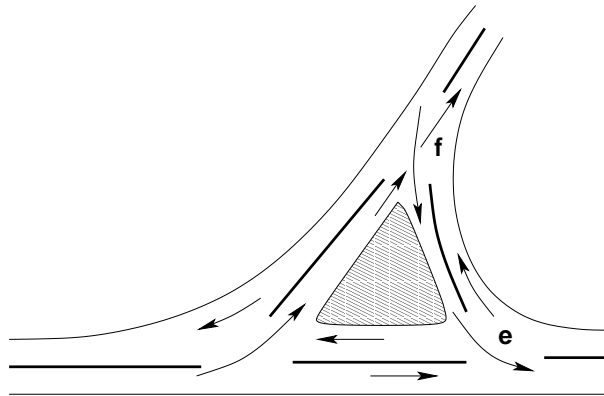

Figure 31:30: Channelization for Y Intersections, (a)For low Flows

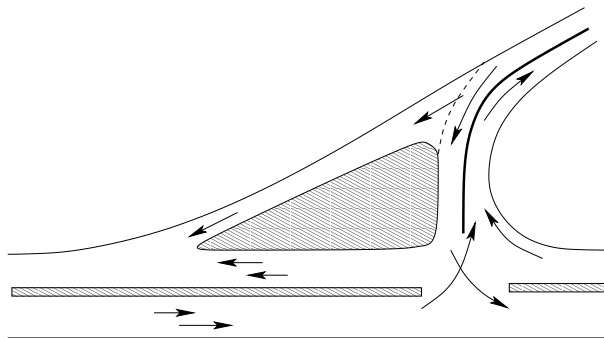

Figure 31:31: Channelization for Y Intersections, (b)For High Flows

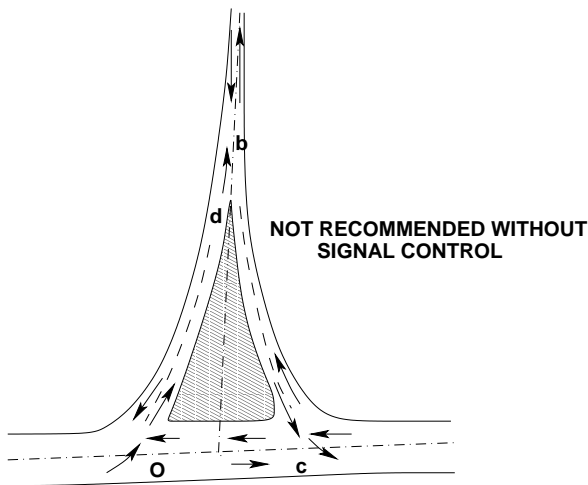

Figure 31:32: Channelization for T Intersections, (a)For low Flows

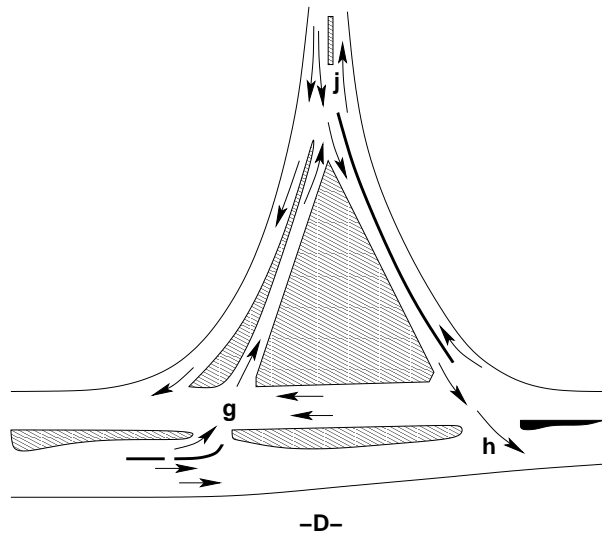

Figure 31:33: Channelization for T Intersections, (b)For High Flows

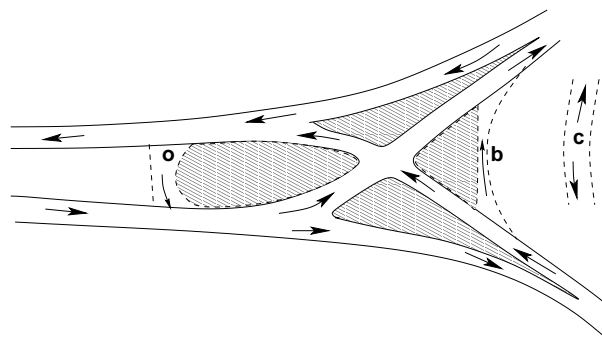

Figure 31:34: Channelization for T or Y Intersections (Channelized-High Type)

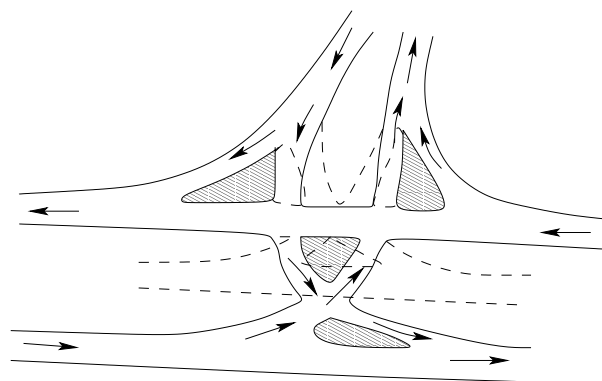

Figure 31:35: Channelization for T or Y Intersections (Channelized-High Type)

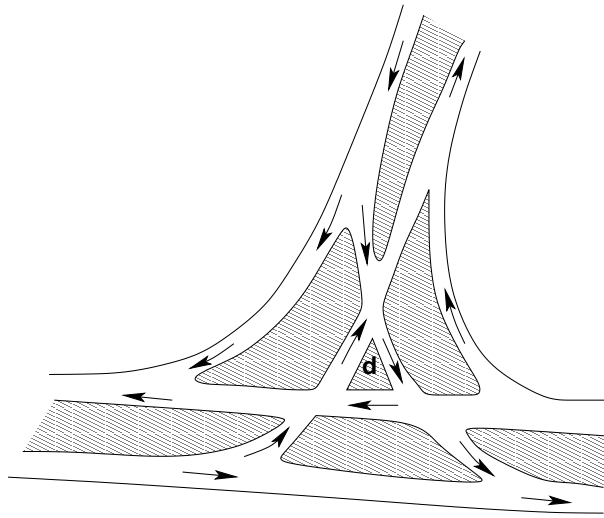

Figure 31:36: Channelization for T or Y Intersections (Channelized-High Type)

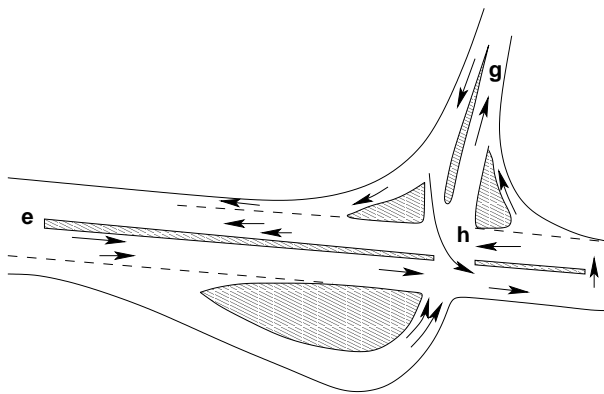

Figure 31:37: Channelization for T or Y Intersections (Channelized-High Type)

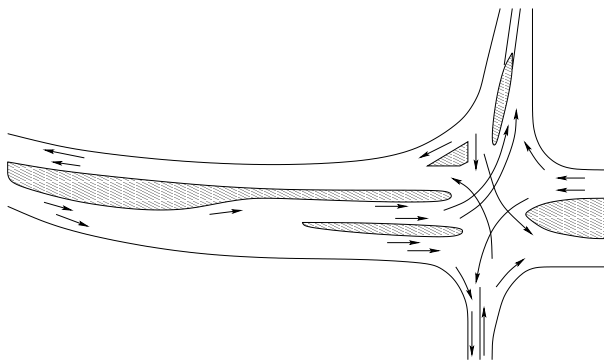

Figure 31:38: Channelization for 4-Leg Intersections (Channelized-High Type)

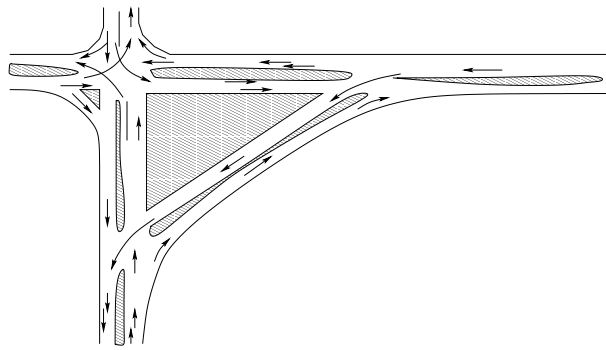

Figure 31:39: Channelization for 4-Leg Intersections (Channelized-High Type)

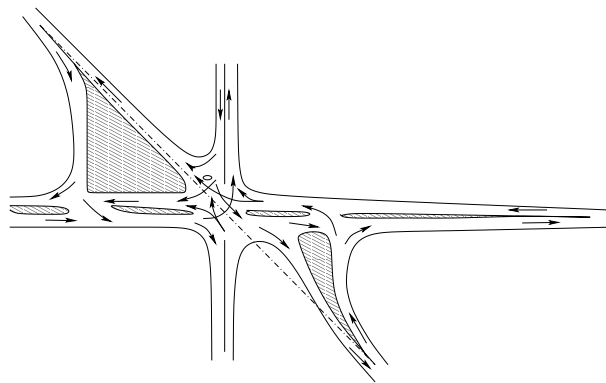

Figure 31:40: Channelization for Multi - leg Intersections

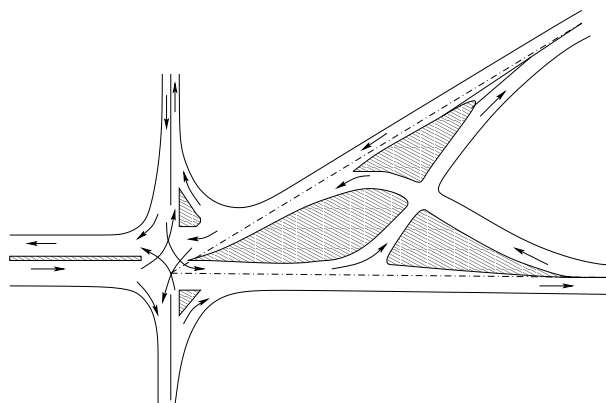

Figure 31:41: Channelization for Multi - leg Intersections

Table 31:10: Dimensions of some common Design vehicles

Design Vehicle Type	Symbol	Overall Dimension		
		Height (m)	Width (m)	Length (m)
Passenger Car	P	1.3	2.1	5.8
Single Unit Truck	SU	4.1	2.6	9.1
Single Unit Bus	BUS	4.1	2.6	12.1
Intermediate Semi-Trailer	WB-15	4.1	2.6	16.7

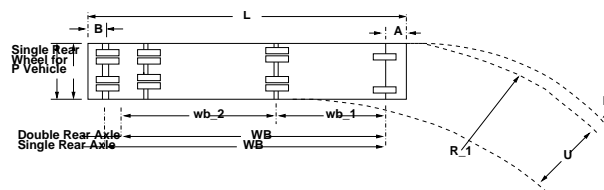

Figure 31:42: Design vehicle Dimensions and Turning Properties

### 31.10 Turning Vehicle Templates

In the design of intersections the turning paths of vehicles assumes utmost importance. The turning paths of design vehicles are given in transparent templates such as the one shown in Fig. 31:17 and Fig. 31:18. These templates are placed over the intersection plan to trace the path of the turning vehicle. Once this is done, proper islands and other traffic control devices can be designed. As per AASHTO, the turning templates are drawn at an approximate scale of 1"=50'. The radius of the template is measured to the outside front wheel path at the beginning of the curve. The design vehicle for the purpose can be taken out of a list of 16 different types of vehicles suggested by AASHTO. The dimensions of some of the design vehicles are given in Table. 31:10 below. The templates are applied to the layout of intersections and other facilities in accommodating vehicle maneuvers, including driveways, car parking, truck loading and bus terminals. Here we shall take the cases of a passenger car (P) and a single unit truck (BUS) as the design vehicles. The various design elements and their dimensions are shown in Fig. 31:42 and Table. 31:11 respectively. The templates were developed to include a variety of angles, with specific configurations for every 30 degrees of turn (30, 60, 90, 120, 150 and 180). By special manipulation of the template, any degree of turning can be produced within an overall range of 20 to 200 degrees. The four variables-vehicle type, turning radius, angle of turn and scale-provide full flexibility in the use of turning vehicle templates for layout and design. To permit greater latitude in maneuvering of buses, single unit trucks and passenger cars, special bar tenders are included, consisting of turning radii in the range of 13 to 50 meters for the

Table 31:11: Design vehicle Dimensions and Turning Properties for 90° turns

Vehicle Designation	L(m)	WB (m)	A(m)	B(m)	W(m)	U(m)	Minimum Turn		
							U** (m)	FA (m)	RT (m)
BUS	12.1	7.5	2	2.5	2.6	2.6	4.98	1.25	13
Passenger Car (P)	5.8	3.4	0.9	15	2.1	1.8	2.61	0.6	7.5

Table 31:12: List of Templates

Vehicle Type	Scales	Turning Radius-m	Average Size-cm
BUS	1:250	R= 13 & 18	20 × 25
	1:500	R= 13 & 18	18 × 18
	1:250	R=13 to 50	20 × 25
Bar Template			
Passenger car	1:250	R=7.5	18 × 18
	1:250	R=7.5 to 30	18 × 18
		Bar template	

first two and 5.5 to 30 meters for the last type of vehicles which are outside the scope of this discussion. The list of templates for bus and passenger cars is shown in the Table. 31:12. The templates for the Passenger Car (P) and Bus are as shown in Fig. 31:43, 31:44 below.



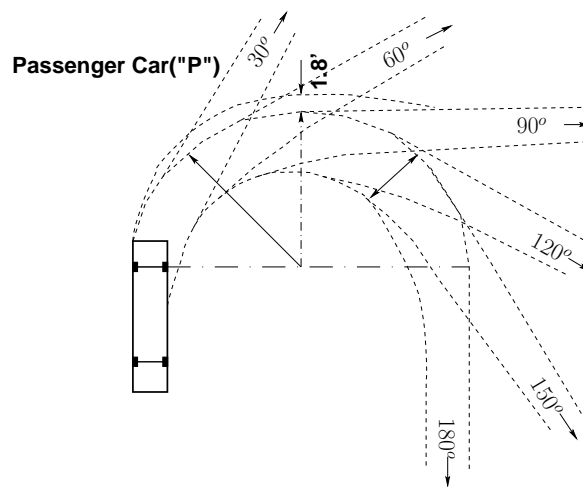

Figure 31:43: Design Template for Passenger Car (P)

### Numerical example 1

Provide Channelization for an intersection having EW as the major road. The major and minor roads intersect at right angles. The design vehicle is WB-50 ( $R=25\text{m}$ ) and design speed is 45 kmph. The intersection is unsignalized. EW road has 2 lanes in each direction and NS has 1 lane for each direction. Take lane width = 3.6 m. Provide bullet nose median ends. Also provide channelizing island for free right for WS bound traffic.

**Solution** : The approach taper for auxiliary lane is equal to  $3.6 \times 45 \times 45/100 = 73 \text{ m}$ . The deceleration Taper is taken as 40 m. Considering a 1:10 taper, the Bay Taper is found out to be 18 m. Let the storage length = 30 m (say). Now from Table. 31:9, it is found that for bullet nose median end, Median Opening = 30 m. The dimensions of all the components of the auxiliary lane are shown in Fig. 31:45. The width required for the WB- 50 semi-trailer unit is found to be about 6.5 m. Additional 0.5 m is provided on the outer side and 0.3 m is provided on the inner side away from the edge of the island. For the turning roadway for the W-S direction, the single offset method is used. At  $0.3 + 0.5 + 6.5 = 7.3 \text{ m}$  from the island edge, a circle of radius 25 m is laid out. Then two tapers of slope 1:15 is laid out on either side of the arc to join with the straight edge on either side. Thus the Channelization is provided for the W-S approach. Similar method can be used for designing the Channelization schemes of the other directions as well. The Channelization for the W-S approach is shown in Fig. 31:46.

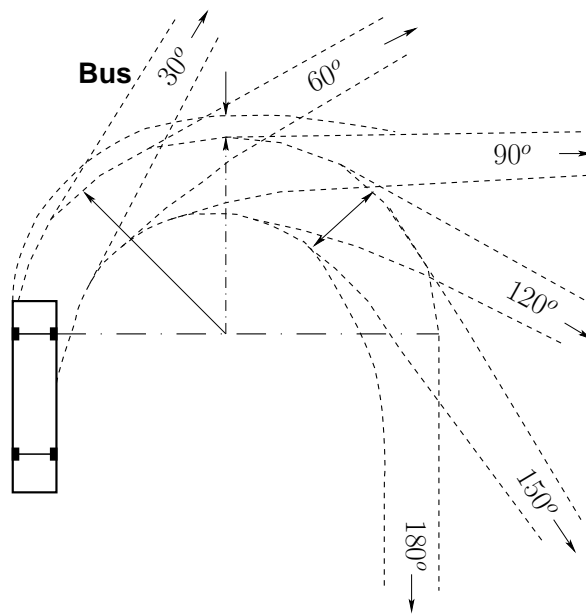

Figure 31:44: Design Template for Bus

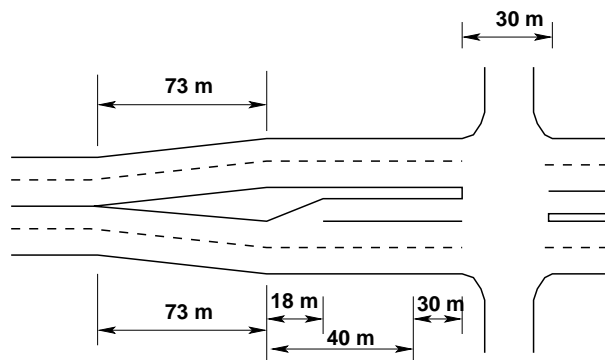

Figure 31:45: Dimensions of components of the auxiliary lane for the intersection

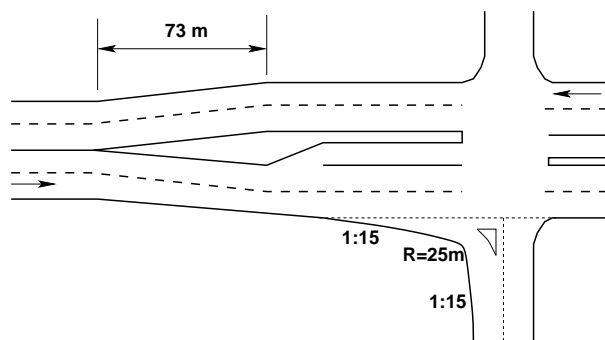

Figure 31:46: Channelization for the W-S direction with traffic island

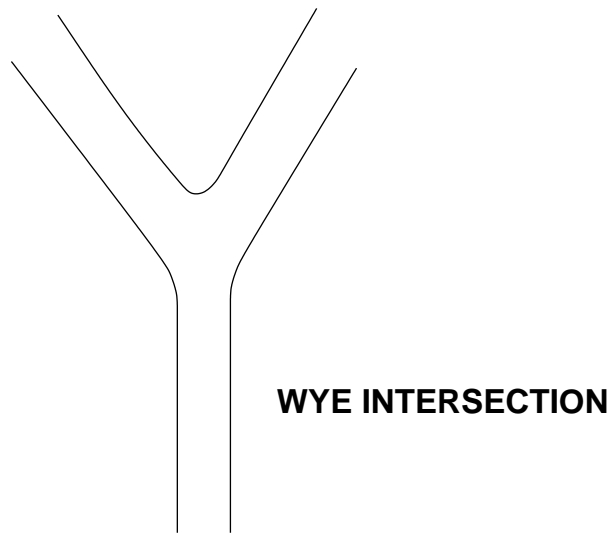

Figure 31:47: Wye Intersection

### Numerical example 2

Following the principles of Channelization suggest suitable island schemes for the following intersections (considering both high relative speed and low relative speed) (Figs. 31:47, 31:48)

### Solution

1. Y Intersection (Figs. 31:49, 31:50 and 31:51)
2. Skewed intersection (Figs. 31:52, 31:53 and 31:54)

## 31.11 Summary

This chapter presents one of the simple and cost effective way of intersection control, namely the Channelization. This is normally adopted for low and medium volume roads. The chapter contains the design principles, traffic islands, and median.

## 31.12 References

1. Transportation research board channelization-the design of highway intersections at grade, 1962.
2. Mass highway, 2006- intersections, 2006.

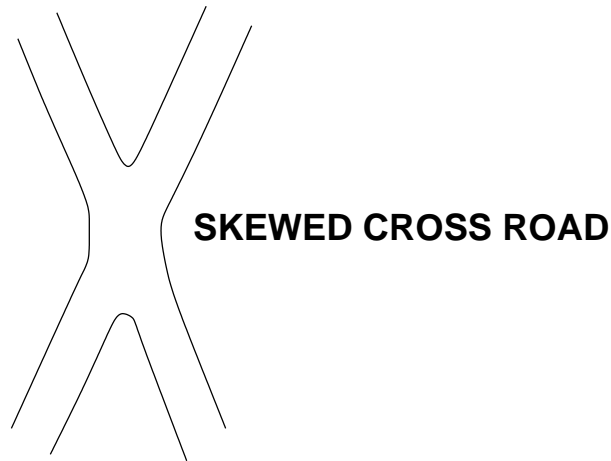

Figure 31:48: Skewed Cross Road

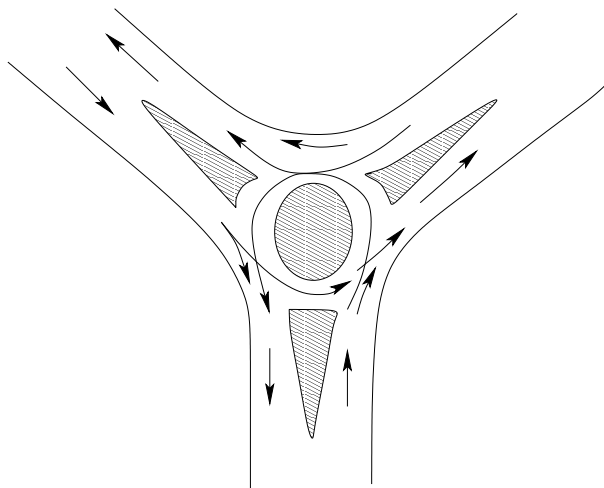

Figure 31:49: (a) Y - Intersection

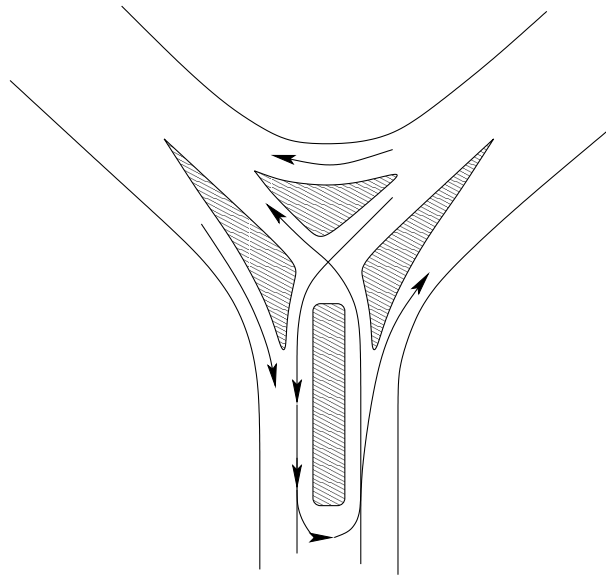

Figure 31:50: (b) Y - Intersection

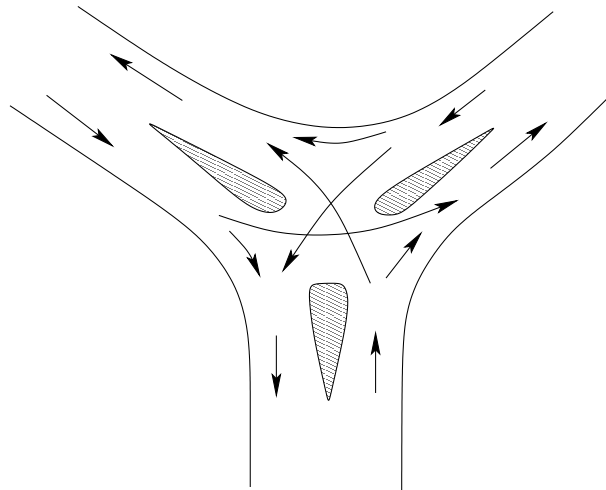

Figure 31:51: (c) Y - Intersection

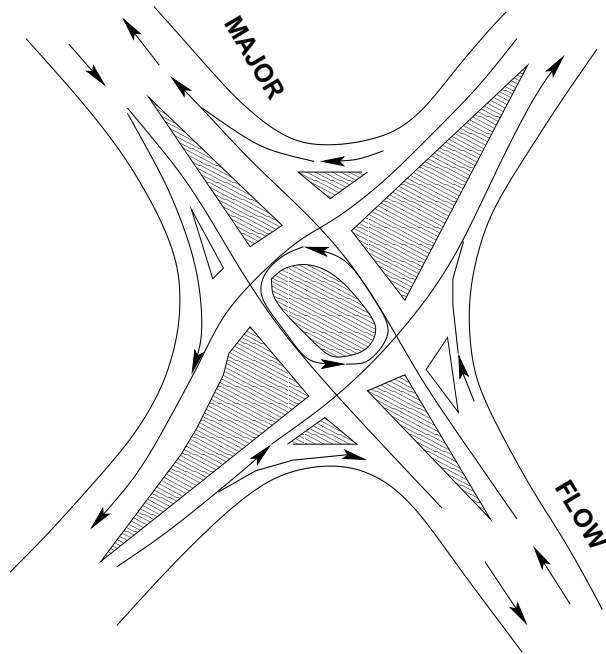

Figure 31:52: (a) Skewed Intersection

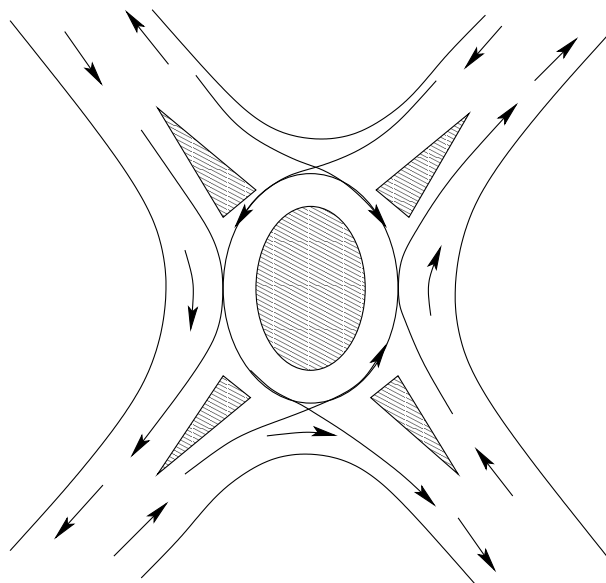

Figure 31:53: (b) Skewed Intersection

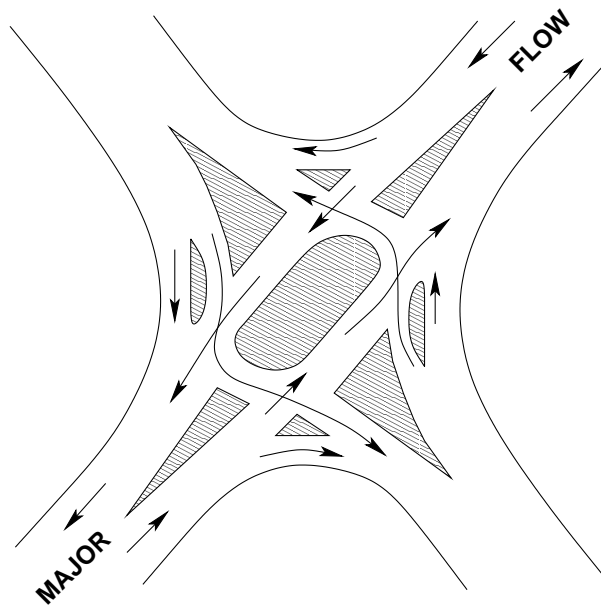

Figure 31:54: (c) Skewed Intersection

3. 2011.
4. Channelization, 2011.
5. Highway design manual, 2000- pedestrian facility design, 2011.
6. Road design manual, 2011.
7. Roosevelt street - neighborhood traffic management plan, 2011.
8. Streetsblog, 2011.
9. Us department of transportation federal highway administration- guidance on the use of traffic channelizing devices at highway-rail grade crossings, 2011.
10. Us department of transportation federal highway administration- innovative intersection safety improvement strategies and management practices:a domestic scan, 2011.
11. Us department of transportation federal highway administration-safety benefits of raised medians and pedestrian refuge areas, 2011.
12. S K Khanna C E G Justo. *Highway Engineering*. Nem Chand and Bros, Roorkee, 2001.
13. T R Neuman. *Intersection channelization design guide*. Transportation Research Board. TRB NCHRP R 279, Washington, D.C., 1985.

14. R J Paquette, N Ashford, and P H Wright. *Transportation Engineering : Planning and Design*. John Wiley, New York, 1972.
15. R P Roess, S E Prassas, and W R McShane. *Traffic Engineering*. Pearson Education International, 2005.
16. S Wolfgang, Homburger, and James H Kell. *Fundamentals of Traffic Engineering 12th Edition*. San Francisco, 1997.